

Table of Contents

Content	Pages
Important information	8
VIN number and engine number	8
Overloading	9
Operation of new vehicle	10
Uses and precautions of new vehicle	12
Services and Maintenance	12
Switches and instruments	13
Steering wheel control	14
Instrument cluster	20
Floor operating mechanism	20
Other instructions	34
Before driving your vehicle	50
Operation control	50
Driver checklist (daily check)	57

POWERSTAR

Driving.....	67
Preparations before starting the engine.....	67
Engine start:.....	67
Stopping of the engine.....	69
Operation of turbocharged engine.....	69
Before driving off.....	70
Parking.....	71
Driving precautions.....	71
Driving for economy.....	75
Precautions about driving in winter.....	76
Driving on snowy or frozen roads.....	78
Precautions for vehicle use in tropical area.....	79
In case of an emergency.....	80
Services and Maintenance.....	92
Maintenance schedule.....	92
Maintenance guide.....	103
Recommended oils and diesel.....	103
lubricating oil.....	134
lubricating oil table.....	137



The logo features a stylized, abstract shape in shades of blue and red, resembling a flame or a wing. Below this graphic, the word "POWERSTAR" is written in a large, bold, sans-serif font. "POWER" is in blue and "STAR" is in red.

POWERSTAR

Parts for grease filling	138
Lubrication guide.....	140
Special equipment operation	152
Use and maintenance of the towing vehicle	152
Electronic Tuning AM Radio with Clock	152
Cassette player with electronically tuned radio and clock	156
Loading method.....	169
Main data and specifications	172

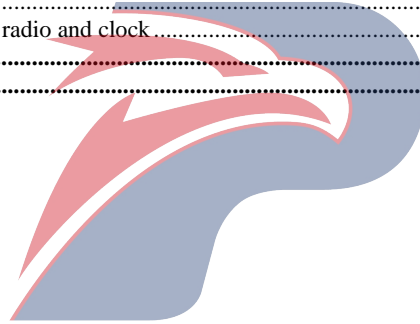

POWERSTAR



Important information

It is important to be familiar with and master the performance of the Isuzu trucks, which are described in the following countries. Before driving QingLing vehicle, must fully understand and follow the following provisions.

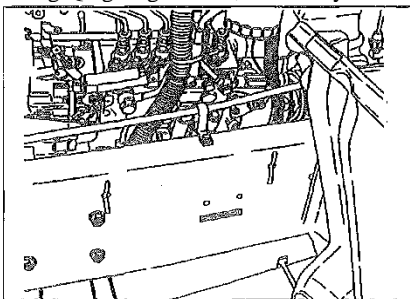

VIN number and engine number

The VIN number and the engine number are important when for users to contact QingLing Motors to order parts, so it is best to write it down.

VIN marking location:

The VIN number is marked on the outside of the front part of the frame.

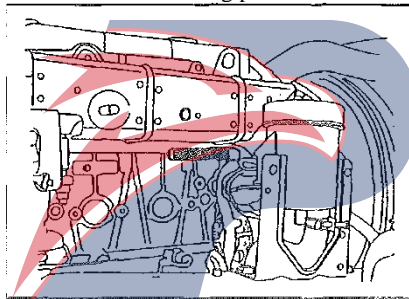

Engine number marking position (6HHI)

The engine number is engraved on the top right front side of the cylinder block.

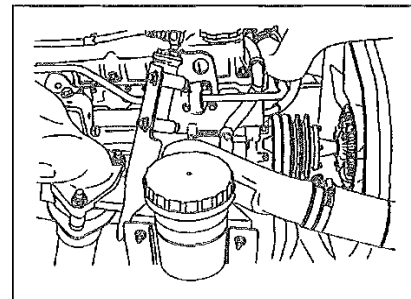

Engine number marking position (6HK1-TC)

The engine mark is engraved on the lower left side of the cylinder block.

POWERSTAR

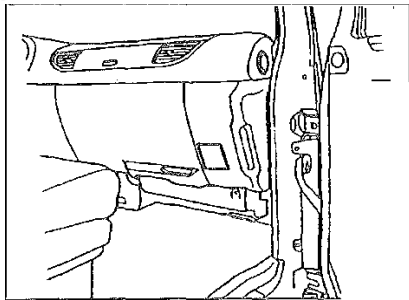

Vehicle nameplate

The vehicle nameplate is mounted on the lower part of the instrument panel on the side of the co-driver's seat.

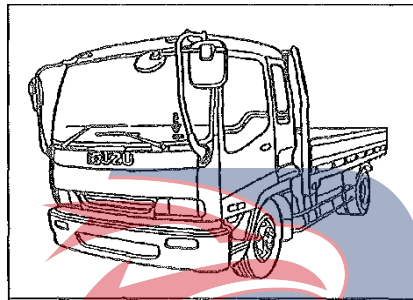

The vehicle identification signage is mounted on the left side of the dashboard.

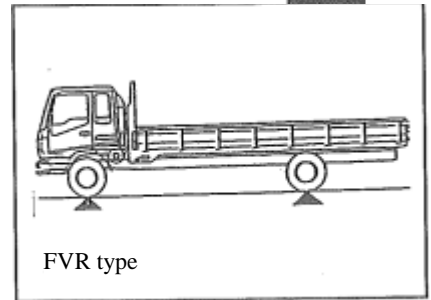

Overloading

Any overloading not only shortens the service life of the vehicle, but also causes a serious failure and even an accident.

The effective load of the cargo must be controlled within the range of the rated load of the vehicle. Meanwhile, the cargo should be evenly installed between the front and rear axles of the vehicle, and the load of the front and rear axles shall not be exceeded.

Please refer to "Main Data and Specifications". These instructions clearly describe the rated total weight of the vehicle and the loads on front and rear axles.

POWERSTAR

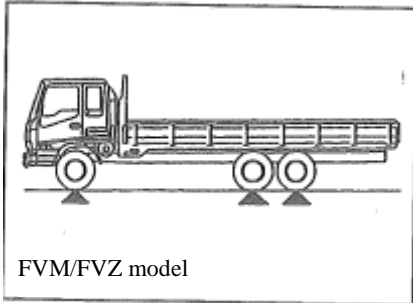

FVM/FVZ model

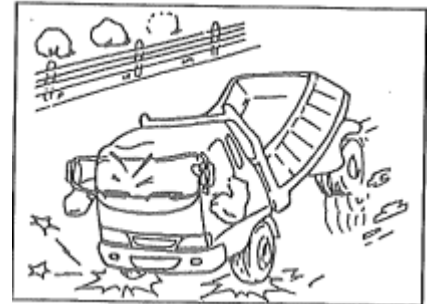
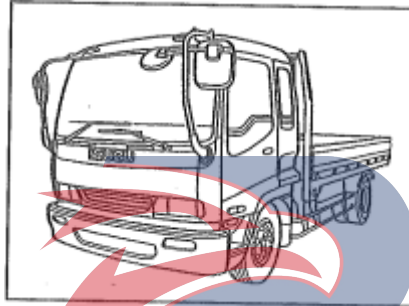

Operation of new vehicle

Whether the use of a new vehicle is good or not, has a great influence on the service life of the vehicle, and the technical and economical efficiency of the vehicle. Therefore, we must strictly observe the following precautions and carefully handle the use of the new vehicle.

1. It is required that the speed of your driving within 3,000 km of the shed should be controlled within the range shown in the table below.

2. Must avoid engine idling operation at high-speed, sudden start and braking and other similar driving operations.

POSTAR



Maximum permitted speed in kilometers (km/h) in the initial 3000 km

Model	Transmission	1st gear	2nd gear	3rd gear	4th gear	5th gear	6th gear
FVR (6HH1)	6th gear variable speed	11	17	27	41	63	75
FVR (6HK1)	6th gear variable speed	12	19	32	54	83	85
FVM (6HK1-TC)	6th gear variable speed	11	18	31	52	78	80
FVZ (6HK1-TC)	6th gear variable speed	10	17	29	49	74	75
CXA (6HK1-TC)	6th gear variable speed	10	17	29	49	74	75
GVR (6HK1-TC)	6th gear variable speed	12	19	32	54	74	75
GVZ (6HK1-TC)	6th gear variable speed	10	17	29	49	74	75

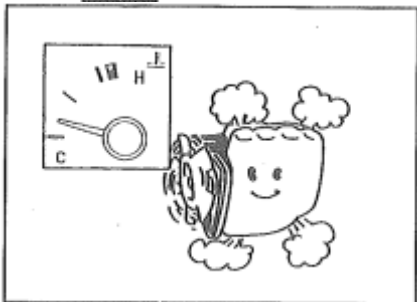

3. Run the engine at idle until the engine is warmed up.

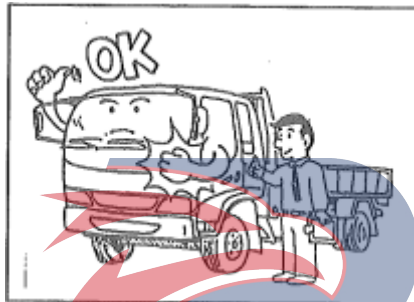

Uses and precautions of new vehicle

All parts and systems of the vehicle must be inspected. Please refer to the instructions in "Switches and Instrument", "Before Driving the Vehicle" and "Driving" for inspection.

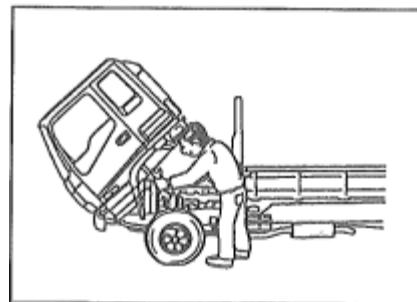

Services and Maintenance

For safe repair, maintenance and reliability of the vehicle. Check and adjust the relevant parts of the vehicle. This can be done according to the chapter "Services and Maintenance".

Warning:

The engine control module is installed on the lower left side of the co-driver seat. It cannot be flushed with water and heated at temperature of above 50°C!

POWERSTAR



Switches and instruments

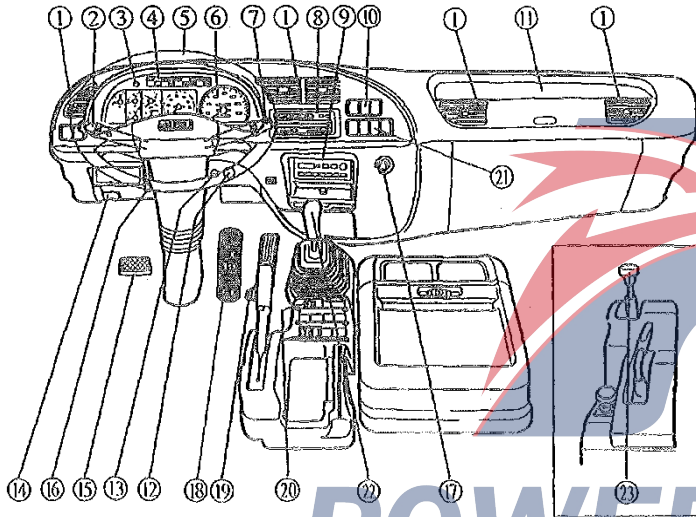

- ① Ventilation equipment
- ② Combination switch
- ③ light bulb check switch
- ④ Indicator lamp/alarm light
- ⑤ Steering wheel
- ⑥ inspection of instrument panel
- ⑦ Windshield wiper and scrubber switch
- Exhaust brake switch
- Danger warning lamp flash switch
- ⑧ OPT Heating control dashboard
- OPT Air conditioning control dashboard
- ⑨ OPT AM radio
- OPT AM/FM Radio and Cassette Stereo Recorders
- ⑩ Power output control switch (if equipped)
- ⑪ Fuse box
- ⑫ Idle control knob
- ⑬ Control resistance
- ⑭ Front cover release handle
- ⑮ Clutch pedal
- ⑯ Steering wheel adjustment locking handle
- ⑰ Cigarette lighter
- ⑱ Brake pedal
- ⑲ Accelerator pedal
- ⑳ Power socket
- ㉑ FVZ Middle differential lock switch
- ㉒ Shift lever
- ㉓ Spring brake valve handle

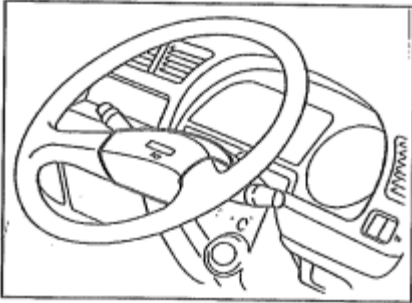

Steering wheel control

Steering wheel and horn button

The horn button is mounted on the steering column and the horn is pressed to whistle. Do not turn the steering wheel when the vehicle is stopped. When the steering wheel is locked, the vehicle cannot be moved; otherwise the vehicle may be damaged.

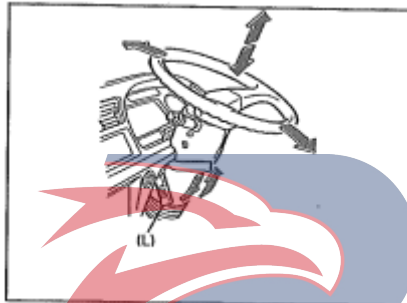

Fully adjustable steering wheel

The steering column can be adjusted to different inclinations, and the steering wheel can also be adjusted up and down. Before adjusting the steering wheel, the driver's seat should be placed in the most comfortable position. After the steering wheel is adjusted, the steering wheel adjustment locking handle should be fastened fully. Be sure to adjust the position of the steering wheel when it is parked; do not adjust it when driving.

Adjustment steps:

1. Turn the lock handle (L) for steering wheel adjustment upwards to release the steering column.
2. After sitting in the middle of the seat, adjust the steering wheel up and down and adjust the steering column back and forth to place it in the desired position.
3. After positioning the steering wheel, turn the steering wheel downward to adjust the locking handle to lock the steering column.

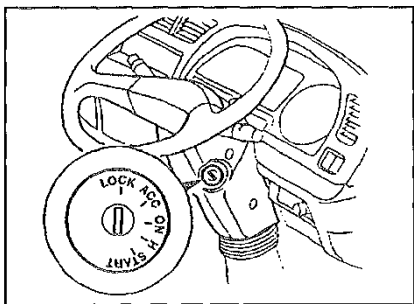

Starter switch

As shown, there are five positions on the switch

“LOCK”: the car key can be inserted or removed in this position.

The steering wheel is locked when the key is removed.

The engine will be shut down when turning the key back to “ACC” or “LOCK” position.

“ACC” (accessory): in this position, the accessory circuit is switched on.

“ON”: keep the key in this position when the vehicle is in use.

“H” (warm - up): turn the key to this position to warm up the engine.

“START”: the engine starts when the key is turned to this position. When the key is released, it will be automatically returned to “ON” position.

Do not operate the engine more than 10s in every time.

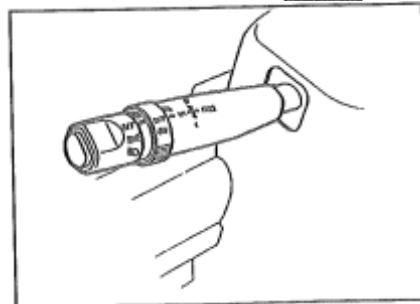

Combination switch

The combination switch is used to control headlights, turn signals, headlight dimmers, and marker range lights.

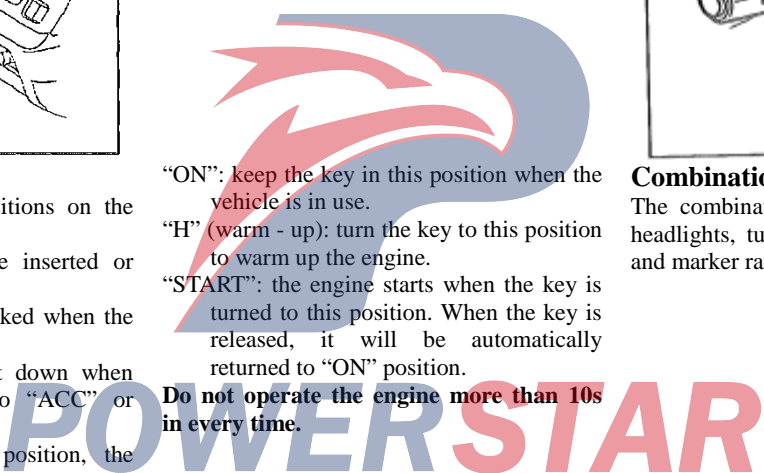

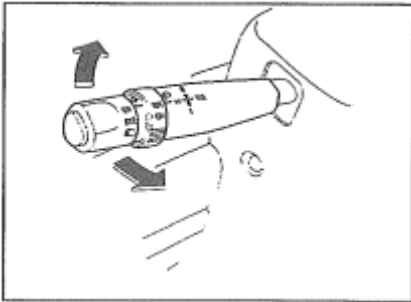

Turn signal switch

Turning the rotary handle of the combination switch can make the external turn signal light up and at the same time send out an off indication on the dashboard.

When the steering wheel is returned to the forward driving direction, the switch handle should be returned to its original position.

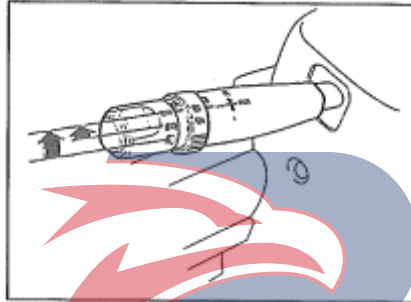

Light control switch

There are two gears to operate the switch to control the following lights: First gear: marker lights, taillights, license plate light, and instrument cluster light. Second: Headlights and lights other than the above.

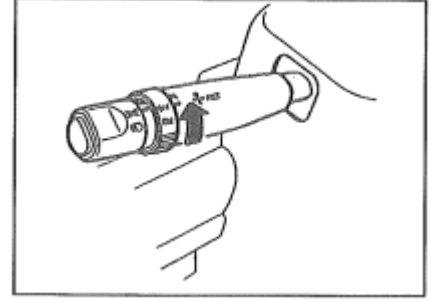

OPT Fog lamp switch

When the lamp control switch has been pulled to the first or second position, turn the switch to the "ON" position to illuminate the fog lamp.

POWERSTAR

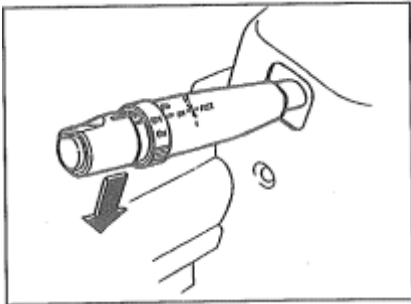

Headlight dimming switch

Move the switch handle up and down to shift the headlight from high beam to low beam or from low beam to high beam. When the high beam of headlight is turned on, the high beam indicator on the dashboard should also be turned on.

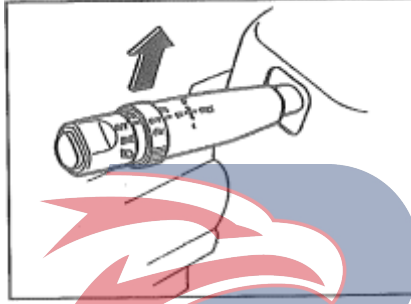

Passing light switch

When the headlight control switch is in "OFF" or 1st gear position, if the combination switch handle is continuously toggled, the high beam will be turned on and off. To send an overtaking signal, the handle must be operated repeatedly. During the day, the light flashes, and at night, the overtaking signals are sent out by the low beam and high beam switching alternatively.

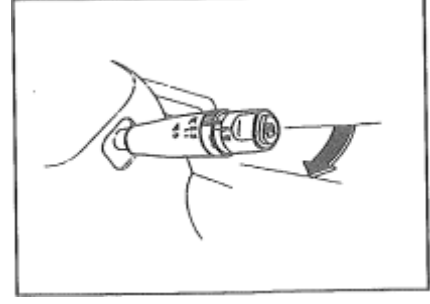

Exhaust brake switch

The exhaust brake system closes the exhaust pipe when the engine brake is applied, thereby improving the braking effect. When the switch handle is pulled, both the clutch and accelerator pedals are released and the indicator lamp is on, which indicate that the exhaust brake is operating.

POWER STAR

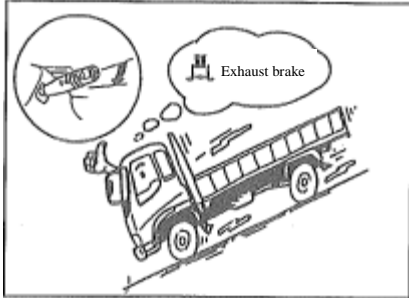

When driving on a downhill or on a road with high traffic signals, the exhaust brake should be fully applied. When the accelerator or clutch pedal is depressed, the exhaust brake stops working.

The exhaust brake switch should remain in the “OFF” position when the engine is warmed up at idle.

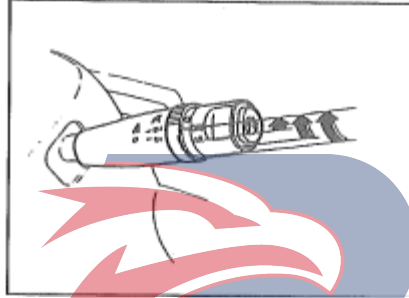

The windshield wiper switch has 4 positions to control the speed of the wiper.

- ①Close ②Intermittent
- ③Low speed ④High speed

When the windshield is dry, do not operate the wiper to avoid scratching the glass. In snowy or icy days, the wiper cannot be used, to avoid any damage.

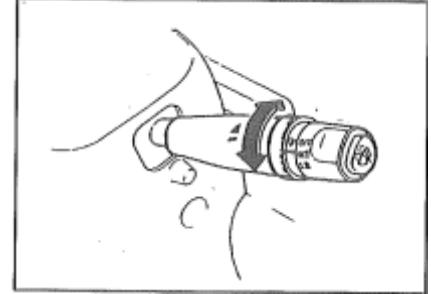

Intermittent wiper control switch

When the windshield wiper switch is in the second “INT” position, the switch can be turned to adjust the intermittent swing interval of the wiper.

POWERSTAR

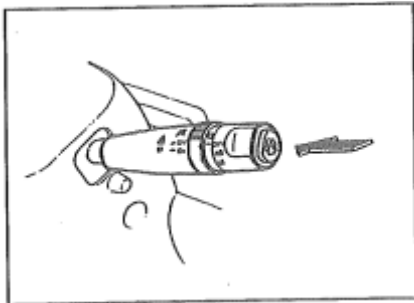

Windshield washer switch

Press the switch button and the washing liquid can evenly sprayed on the windshield. This switch is used to operate the power output shaft device. When the switch is pulled out, PTO shaft will be operated and PTO shaft indicator will be turned on.

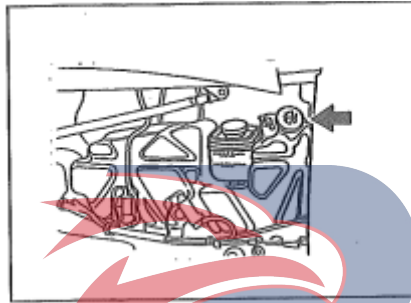

Windshield washer tank

The tank should be filled with genuine Isuzu washing liquid.

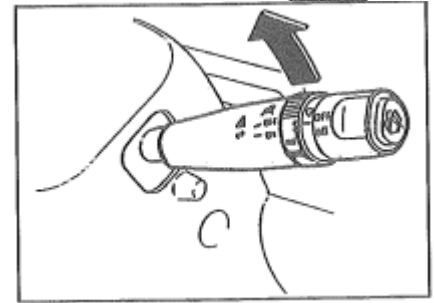

Danger warning flash switch

When the switch handle is lifted upwards, all the turn signals will flash regardless of the position of the turn signal switch. Lift the switch handle again to turn off the hazard warning flash.

The hazard warning flash switch can be only used when the vehicle may cause a traffic accident.

POWERSTAR

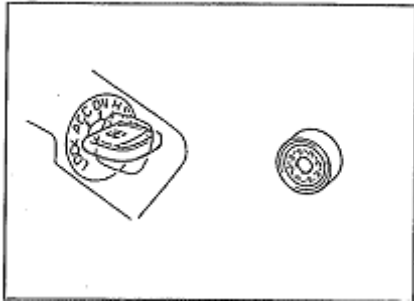

Instrument cluster Control resistance

When the engine glow plug is warmed up completely, the control resistance will be heated.

Under normal conditions, after 15~20s from turning the start switch to “PREHEAT” position, the control resistor should become red.

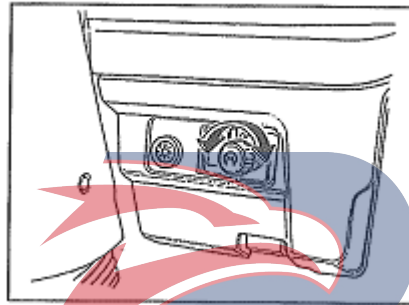

Idle control knob

After the engine is cold started, turn the idle speed control knob clockwise to increase the idle speed. Therefore, it is easy to quickly bring the engine to a normal idle rotation position.

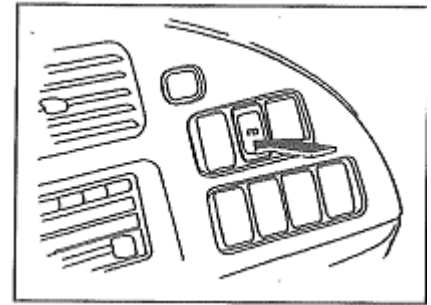

Power output control switch (if equipped)

To use the power output unit (P. T. O.), pull out this switch.

This switch is used to operate the power output shaft device. When the switch is pulled out, PTO shaft will be operated and PTO shaft indicator will be turned on.

POWERSTAR

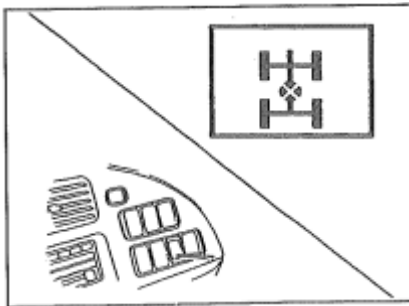

FVZ Middle differential lock switch

Whenever this switch is pressed, the differential lock mechanism is activated, connecting the two axles of the rear axle directly, and the middle differential lock indicator on the instrument panel lights up.

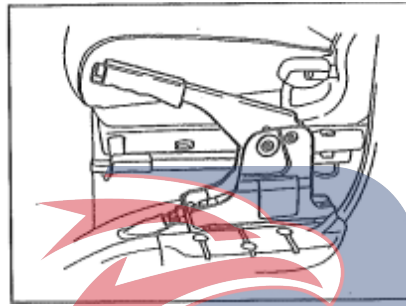

Tipper control lever (if equipped)

Turn PTO switch to "ON" position before operating.

Pull the control lever to raise the tilt stand.

The lever locks automatically when it is fully raised.

When the lever is pulled back, it should be pushed back while pressing the tip button.

*** For detailed instructions on the operation and use of tipping bucket, refer to the instruction manual of each installation manufacturer.**

POWERSTAR



Instruments and indicators

Instrument cluster

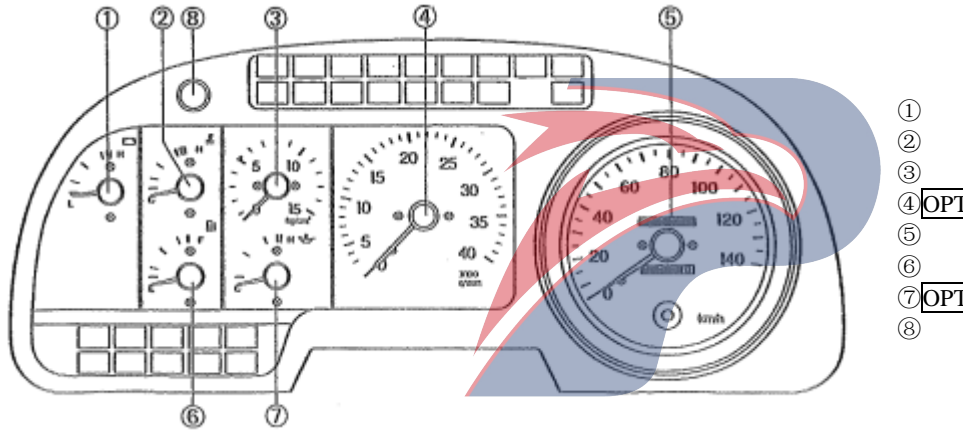

- ① Voltmeter
- ② Temperature gauge
- ③ Air pressure gauge
- ④ **OPT** Tachometer
- ⑤ Speedometer
- ⑥ Fuel gauge
- ⑦ **OPT** Oil temperature gauge
- ⑧ Bulb inspection control button

POWERSTAR



Indicator lamps

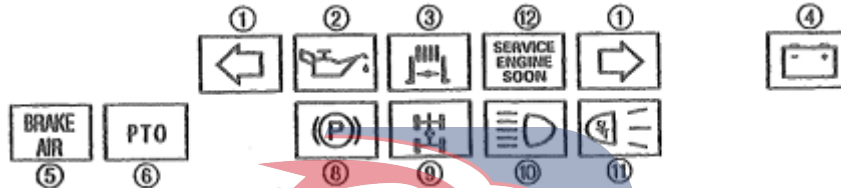

- ① Turn signal indicator lamp
- ② Oil pressure indicator lamp
- ③ Exhaust brake indicator lamp
- ④ Generator indicator lamp
- ⑤ Air pressure indicator lamp
- ⑥ PTO indicator lamp (if equipped)
- ⑧ Parking brake indicator lamp
- ⑨ EVZ Middle differential lock indicator lamp
- ⑩ Headlight high beam indicator lamp
- ⑪ Stop, rear light bulb indicator lamp
- ⑫ Repair engine warning lamp

Note: Refer to the following text when the indicator lamp is on.

POWERSTAR

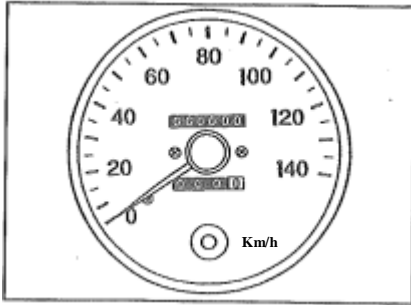

Speedometer

The speedometer is used to indicate the speed in km/h.

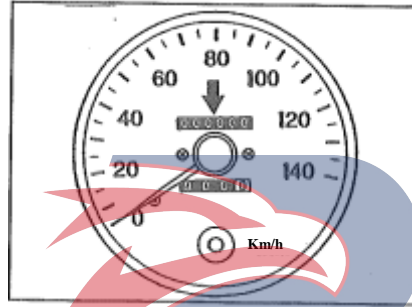

Tachograph

The odometer records the cumulative travel distance in kilometers.

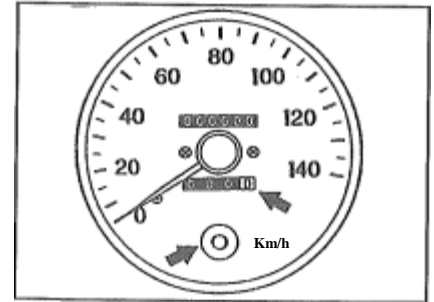

Short distance odometer and reset button

The reset button for short distance mileage display is in the middle part of the lower side of the speedometer.

The white area at the far right side can display 0.1 km (or 0.1 miles).

Push the reset button inward to reset the short distance odometer to zero.

POWERSTAR

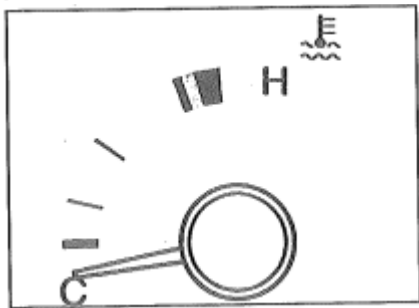

Coolant thermometer

The water temperature indicator indicates the temperature of engine coolant.

When the pointer enters the red range, the vehicle should be stopped and the engine shall be kept idling until the coolant temperature drops to normal temperature.

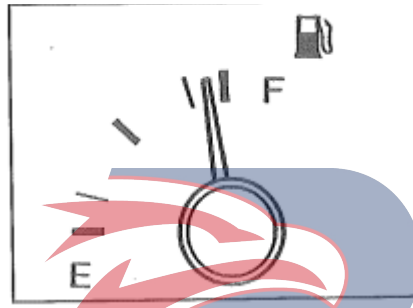

Fuel gauge

When the start switch is in the "ON" position, the fuel gauge indicates the level in the fuel tank. "F" and "E" indicate "Full" and "Empty".

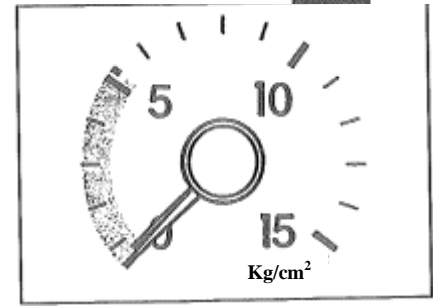

Air pressure gauge

When the start switch is in "ON" position, the air pressure gauge will indicate the air pressure in the main air tank. When driving, the pressure gauge reading should be 7-8 kg/cm².

OPT Double pointer barometer

The pointer near the barometer dial is used to indicate the pressure of the front brake system. Another pointer on the upper side indicates the pressure of the rear brake system.

POWERSTAR

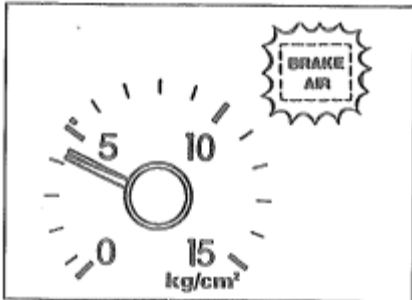

When the pressure is lower than 5.3 kg/cm², the indicator lamp is displayed on the dashboard and the warning buzzer also sounds.

Before the starter is turned off, the buzzer should not sound when the air pressure is up to 5.3 kg/cm².

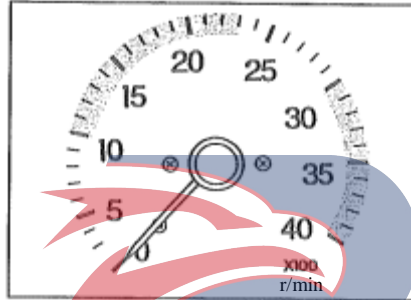

OPT Engine tachometer

The engine tachometer is used to indicate the number of revolutions per minute (rpm) of the engine and the red range indicates the engine speed limit.

Never continue to drive the vehicle with the tachometer pointer in the red range. If the vehicle is driven continuously when the tachometer pointer is within the red zone, it may cause serious engine damage.

Maximum allowable engine speed:

6HH1: 3,000 turns/min

6HK1TC: 2,800 turns/min

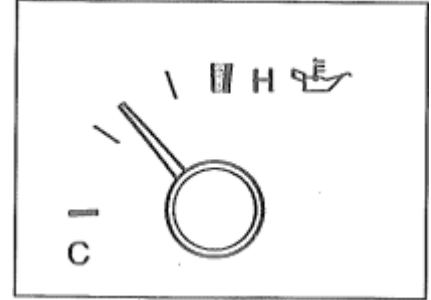

OPT Oil temperature gauge

The oil temperature gauge is used to indicate the oil temperature in the engine oil pan.

If the pointer rises above the red line, it means that the engine is overheated to some extent; therefore, the engine load must be reduced before continuous driving.

It will promote further deterioration of the oil to continuously drive the vehicle at the same speed when the oil is at a high temperature.

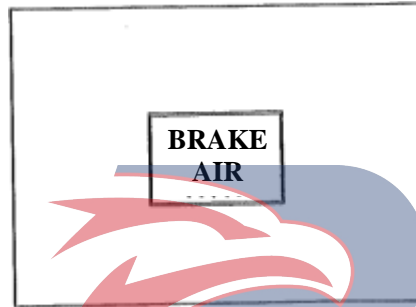
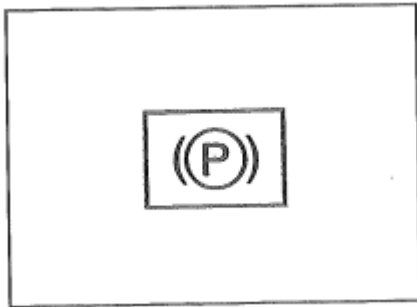

Parking brake indicator lamp

The starter switch is in the “ON” position and the indicator lamp lights up when the parking brake lever is pulled up.

The indicator lamp cannot be used to indicate the application of the parking brake. After parking the vehicle, pay attention to pull up the brake lever.

Air pressure warning lamp

The indicator lamp will be turned on when the air pressure in the tank is below the pressure limit.

If the warning lamp is turned on during driving, immediately park the vehicle and check the fault causes; do not drive the vehicle when the warning lamp is turned on. (Depressing the pedal brake repeatedly may cause a temporary decrease in air pressure.)

Pressure alarm buzzer

The buzzer operates at the same time as the air pressure indicator. When the parking brake lever is pulled up, the buzzer stops but the indicator lamp remains on.

When the lamp is turned on, it indicates that the pressure in the air tank is insufficient, and the brake cannot be applied fully.

Park the vehicle on a safe place and then operate the engine at medium speed to increase air pressure.

When the indicator lamp lights up, do not start the vehicle because the brakes do not work.

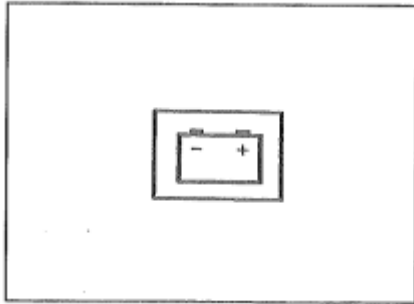

Generator warning lamp

When the starter switch is turned “ON”, the generator indicator lamp lights up, and goes out as the engine starts, which indicate that the generator circuit is working properly.

If the warning lamp is on during driving, the generator circuit has a fault.



Turn signal indicator lamp

When the switch of turn signal light or hazard warning lamp is turned on, the warning lamp flashes together with the turn signal light.

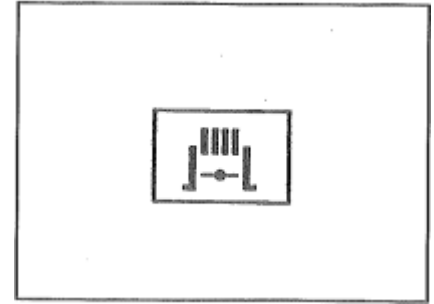

Exhaust brake indicator lamp

When the exhaust brake switch is turned on, the exhaust brake indicator lamp lights up to indicate that the exhaust brake is operating.

POWERSTAR

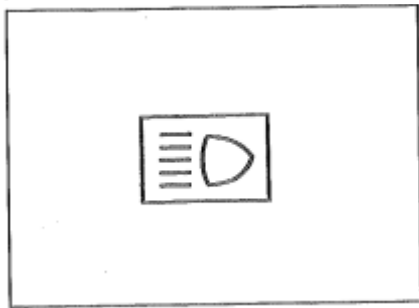

High beam indicator lamp

When using the headlight high beam, the indicator lamp is on.

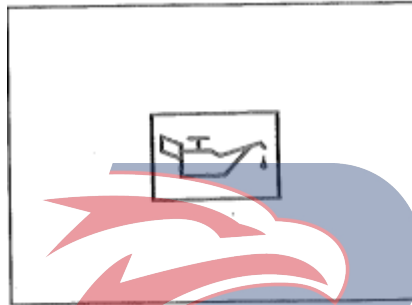

Oil pressure indicator lamp

This indicator turns on when the start switch is turned to the “ON” position, but the start engine turns off.

If this indicator lamp lights up while driving the vehicle, stop the engine immediately to check the oil level in the crankcase of the engine. If the oil level is normal, the location of the fault is limited to the lubrication system. When the indicator lamp is turned on, the engine cannot be started.

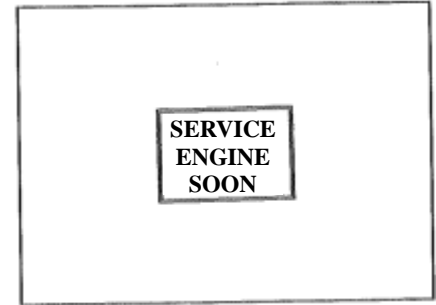

Repair engine warning lamp

This warning lamp turns on when the start switch is turned to the “ON” position, but the start engine turns off.

If the light turns on during driving, it indicates that the engine's electronic control system has a defect.

The vehicle should be driven at a slow speed to the nearest QingLing Motors service station for engine overhaul.

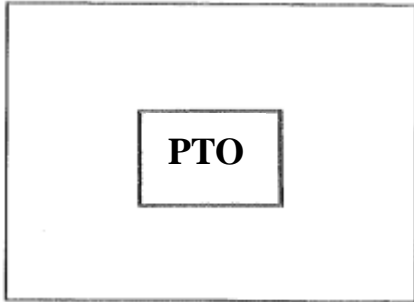

Power output indicator lamp (if equipped)

When the power output self-control switch is operated, this indicator will light up, indicating that the power output device is in working condition.

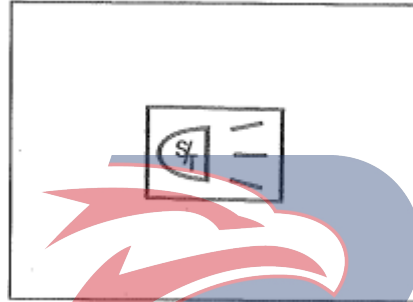

Stop, rear light bulb indicator lamp

When the bulb of the stop lamp or the tail lamp is blown, the indicator lamp will be turned on.

When replacing the lamp, use a bulb with a specified number of volts and watts.

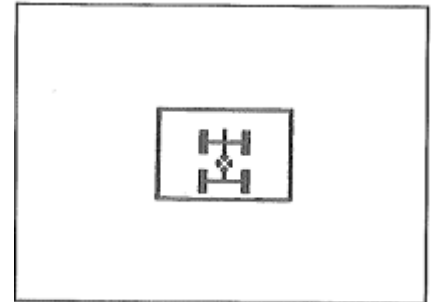

FVZ Middle differential lock indicator lamp

When the middle differential lock switch is collided, the indicator lamp will be turned on, indicating that the two rear axles have been directly connected, and the differential is turned into locked status.

Never operate the middle differential lock during driving.

POWERSTAR



Seatbelt warning lamp (if equipped)

The warning lamp is used to remind the driver and passengers to fasten their seatbelts. Whenever the start switch is turned to the "ON" position, this warning lamp always lights for 4 to 8 seconds. If the start switch is turned on in the state that the seat belt of the driver is not fastened, the beeper will also sound for 4 to 8 seconds.

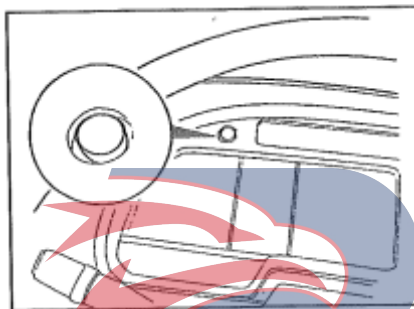

Bulb check switch

Before driving, use this switch to check that the following lights are working properly.

- Air pressure warning lamp
- Braking system indicator lamp
- Engine over speed indicator lamp
- Stop, rear light bulb indicator lamp
- Automatic transmission oil temperature indicator lamp

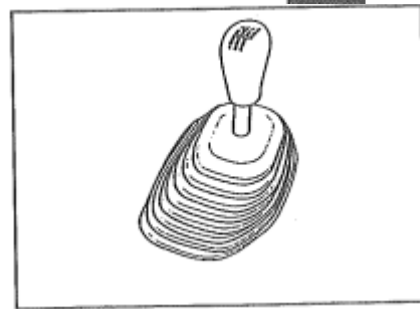

Move the operation mechanism Transmission lever

The shift position diagram is located on the top surface of the shift lever knob. When the start switch is turned in "ON" position and the gear shift level is placed in reverse position, the reverse indicator lamp will be turned on.

[OPT] In case of any equipped reverse alarm, the alarm will sound when the reverse gear is engaged.



MLD model

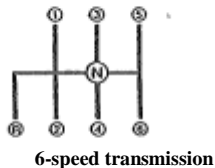

6-speed transmission

MRB model

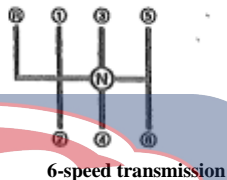

6-speed transmission

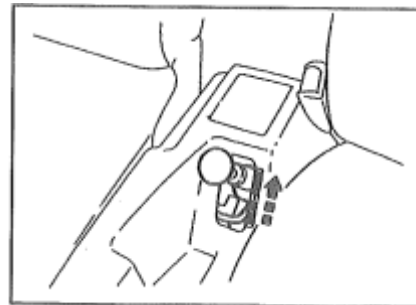

Spring brake valve handle

When the spring brake valve handle is pulled up to the locked position, the spring brake will turn to the braking state and its indicator lamp will be on.

To release the spring brake, lift the spring brake valve handle lock and then push it down.

The spring brake valve handle cannot be operated during driving.

POWERSTAR

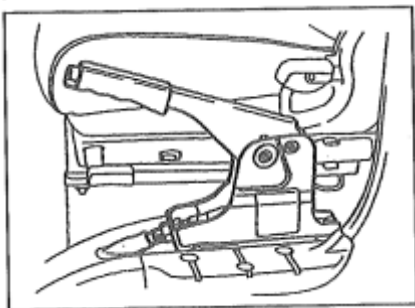

Tilting mechanism control handle (if equipped)

Before operating this handle, turn the PTO switch to the "ON" position.

Pull up this handle to raise the carriage. When the handle is pulled to the highest position, it will be automatically locked. To lower the carriage, hold down the button on the top of the handle and push the handle down.

※ For details on the operation of the dumping mechanism, refer to the operating instructions provided by its manufacturer.

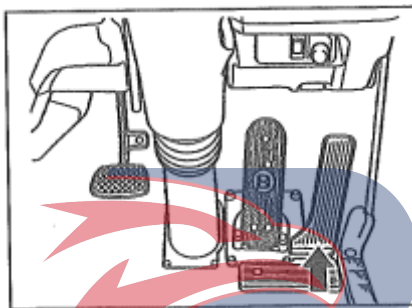

Accelerator pedal

To prevent unnecessary fuel consumption, the accelerator pedal operation must be smooth and appropriate.

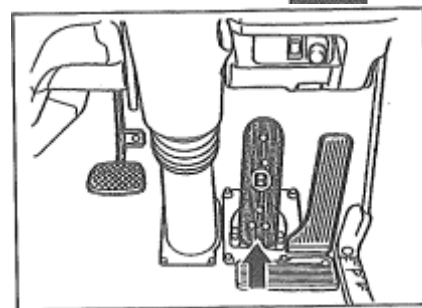

Brake pedal

Even if the brake pedal is gently depressed, the pneumatic and hydraulic brakes will play a powerful braking effect.

When the vehicle is driven on a downhill, must apply the engine brake as possible.

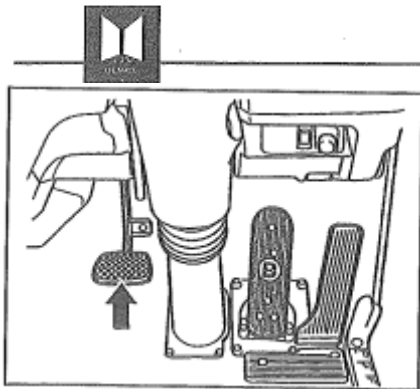

Clutch pedal

The clutch must be fully depressed for disengagement; otherwise the gears may be damaged.

When the clutch is not operated, do not rest your feet on the clutch pedal.

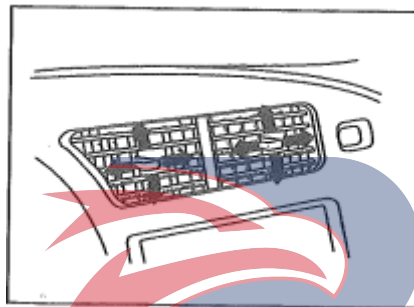

Other instructions

Ventilation device

Turn the grille to adjust the air flow direction.

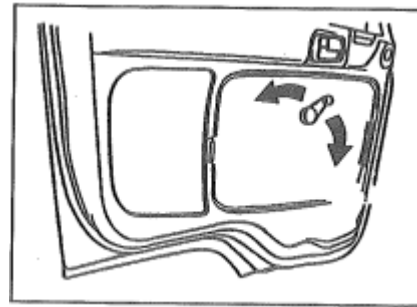

Window adjustment handle

When raising or lowering the side window glass of the cab, swing the window adjusting crank the handle.

POWERSTAR

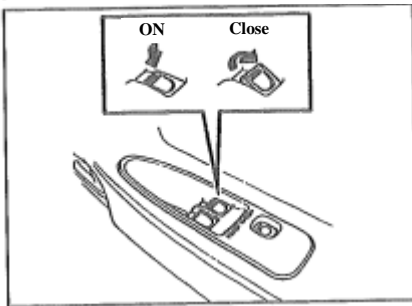

OPT Driver side power window switch
Operation of driver side window switch
Open:

If the front end of the automatic switch is pulled down halfway, the window on the driver's side can be moved downward. As soon as you release the switch, the window stops moving.

If the front end of the automatic switch is pushed down and released, the window can be moved down to the bottom.

To stop the window at the desired position, gently pull the front end of the automatic switch and release it immediately.

If the front end of the automatic switch is pulled up halfway, the window on the driver's side can be moved upward. As soon as you release the switch, the window stops moving.

If the front end of the automatic switch is pushed up and released, the window can be moved up to the bottom. To stop the window in the desired position, gently push the front end of the automatic switch and release it immediately.

In cold areas, when the front end of the switch is pulled up to the end, the safety device can automatically prevent that the windows are closed completely. In this case, gently pull up the front end of the switch so that the window is fully closed.

- The power window switch can also be operated within 30s after the start switch is turned off. This is a very convenient feature if you forget to close the window and turn off the start switch.

- When the windows are closing, be careful not to let your arms block the window closing.

- If an excessive force is applied to close or open the power window, the safety device may be activated to stop the window movement. In this case, turn off this switch. After a few seconds, turn on the switch again and check if the opening and closing of the window is normal.

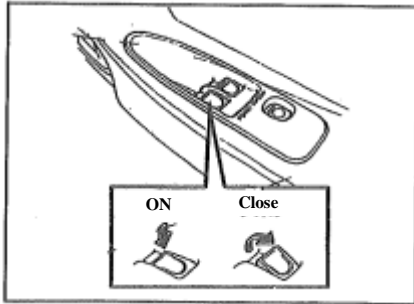

OPT passenger side window switch operation

Open:

Pressing the front end of the switch allows the passenger side window to move downward. As soon as you release the switch, the window stops moving.

Close:

Pulling up the front end of the switch allows the passenger side window to move upward. As soon as you release the switch, the window stops moving.

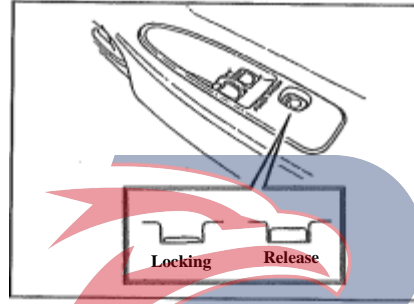

OPT Power window lock switch

Press the power window lock switch once to lock the window on the passenger side to prevent it from opening or closing.

Press this switch again to release the locked state of the window.

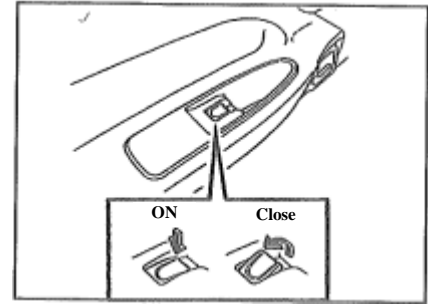

OPT Passenger side automatic window switch

Open:

Pressing the front end of the switch allows the passenger side window to move downward. As soon as you release the switch, the window stops moving.

Close:

Pulling up the front end of the switch allows the passenger side window to move upward. As soon as you release the switch, the window stops moving.

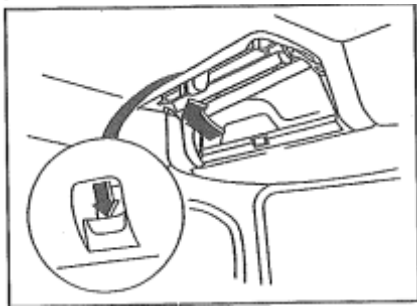

OPT Overhead shelf

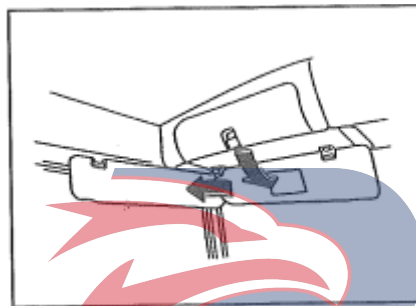

OPT Sun visor
When the sun shines on the face, the sun visor can be lowered.

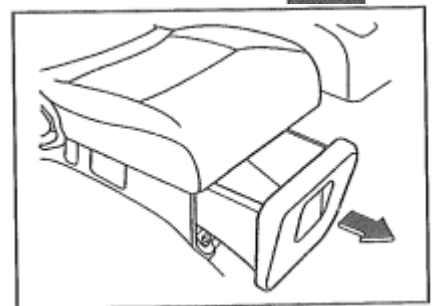

OPT Disc-shaped container on lower side of assistant seat
The storage tray is located below the seat.

POWERSTAR

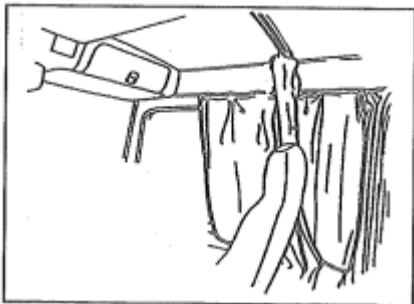

OPT Curtains

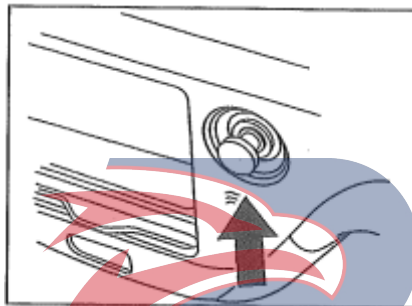

Cigarette lighter

In use, press it down and heat it in about 15s. The cigarette lighter will be automatically returned to its original position after it is heated.

1. When pressing down the cigarette lighter, be sure to use your fingers to press it, and never hold the cigarette lighter by hand. In order to avoid burns.
2. After 18 seconds, the cigarette lighter did not retreat to its original position, indicating that there was a malfunction. Then press the button again to return it to its original position.
3. After the cigarette lighter is pushed in, it is forbidden to leave the vehicle so as to avoid accidental fire.
4. Sometimes the cigar lighter cannot rebound after it is deformed. Please use the new Isuzu cigarette lighter accessories for replacement.

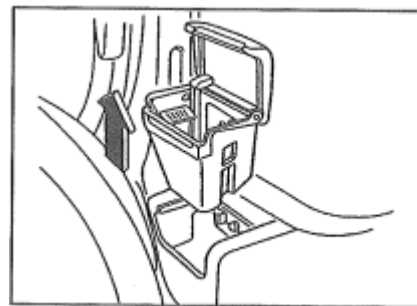

Ashtray

When cleaning the ashtray, pull it out.

The ashtray lid must be closed completely after use, to prevent a fire caused by the burned cigarette head.

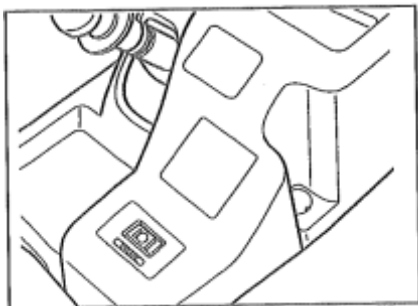

External power outlet

Its maximum allowable capacity is 24V-10A (240W)

Be sure to prevent any overloading

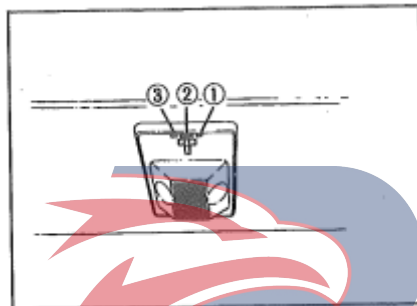

Indoor lights

The indoor switch can be used in any position of the start switch.

- ②“DOOR”: this light comes on as soon as the driver's door is opened.
- ③“ON”: this light is always on regardless of the position of the door.

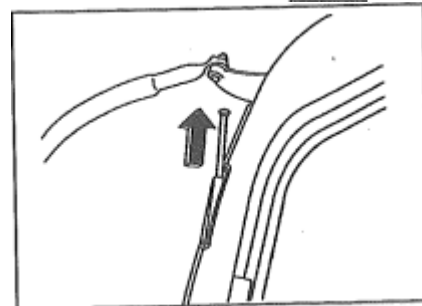

OPT Antenna

Pull out the antenna for better reception.

POWERSTAR

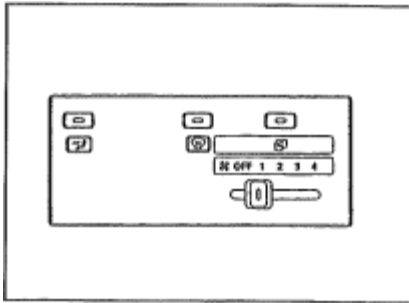

Forced ventilation device

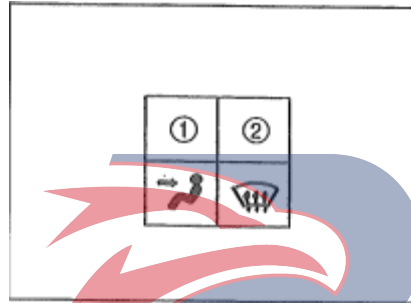

Outlet selection toggle

The air outlet select toggle is used to control the wind direction.

- ① FACE: Air blows to the face
- ② DEF: Air blows to windshield glass

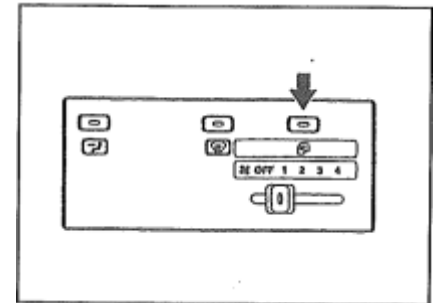

Indoor and outdoor air switching button

The indoor and outdoor air conversion button is used to convert between the two ways of air circulation which are outdoor air or indoor air circulation.

Turn off: Introduce the outside air

Lights up: Circulate indoor air

POWERSTAR

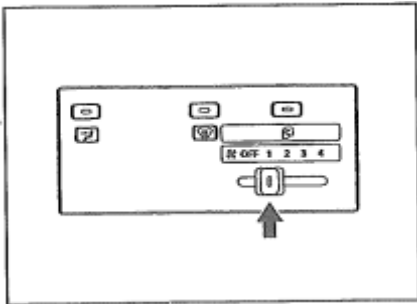

Fan knob

The fan toggle adjusts the air flow rate in four stages.

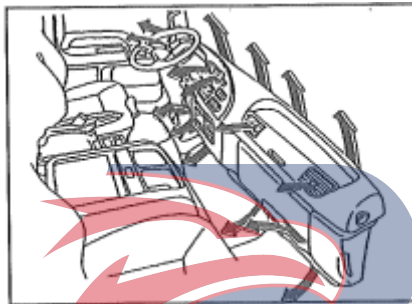

OPT Heating defrosters and air conditioners

Air flows out from each outlet as shown in the figure.

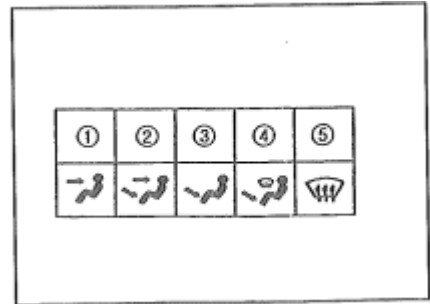

The air outlet select toggle is used to control the wind direction.

- ① FACE: Air blows to the face
- ② BI-LEVEL: Air blows to face and feet
- ③ FOOT: Air blows to the feet
- ④ FOOT/DEF: Air blows to the feet and windshield glass
- ⑤ DEF: Air blown on windshield

POWERSTAR

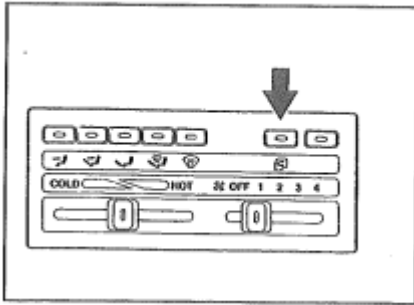

Air intake switch

The air intake switch controls the outside air and the device that directly circulates air through the air intake duct.

Turn off: Introduce the outside air

Lights up: Circulate indoor air

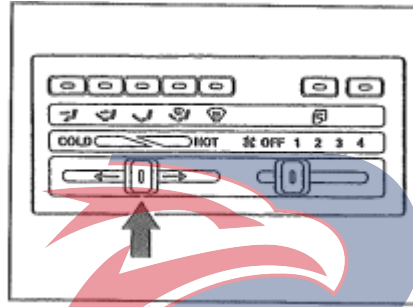

Temperature adjustment button

Temperature toggle control temperature (by controlling hot water flow rate)

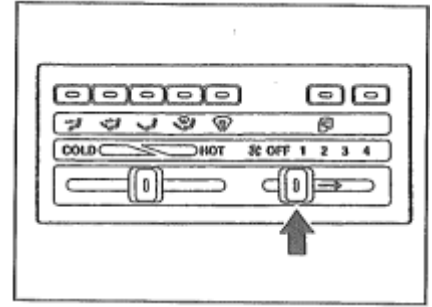

Fan knob

The fan toggle controls the four speeds of the air flow rate.

POWERSTAR

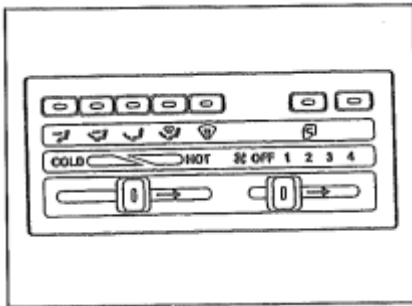

Heating in winter

When the engine coolant temperature rises, adjust the toggle as shown on the left. Use the temperature toggle and fan toggle to control the room temperature.

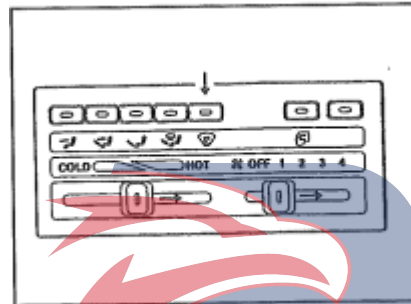

Fan defog

Use temperature toggle and fan toggle to control the flow of air temperature to defrost and defog

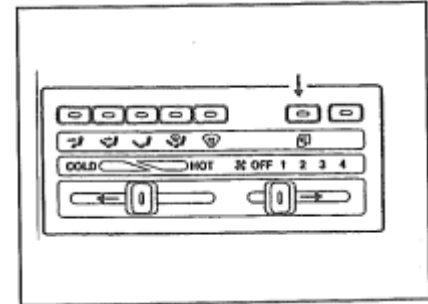

Forced ventilation

When the dial button is turned in the position shown in the figure, the outside air can be entered for circulation through the exhaust manifold grille. A large air flow should be controlled with the fan button.

POWERSTAR

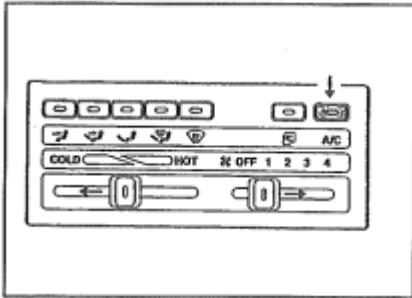

OPT Indoor air control (used in vehicles with air-conditioner)

The room temperature can be adjusted to the desired temperature. Press "A/C" (air conditioning) button to turn on the air conditioning, and press the button again to turn it off.

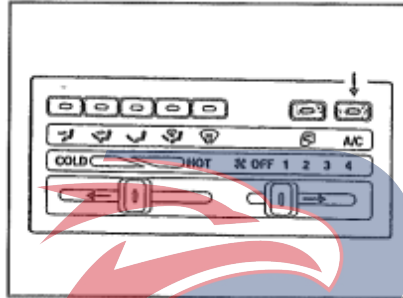

OPT Summer air conditioning (used in vehicles with air-conditioner)

Press the "A/C" (air conditioner) button, and place the temperature toggle in the position shown in the figure. If rapid cooling of the room is required, place the air inlet switch in the "indoor air circulation" position and press and switch the fan toggle to the "4" position.

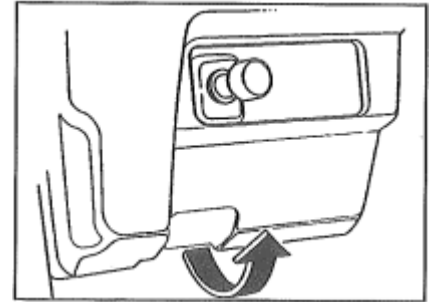

Front cover release handle

The release handle of front cover is located on the instrument panel at driver's side.

POWERSTAR

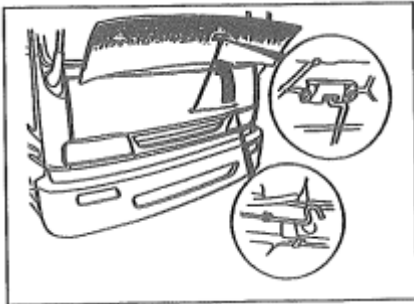
**On:**

1. Pull the front cover release handle and release the front cover lock.
2. Raise the front cover and insert the front cover support bar to maintain the front cover open.

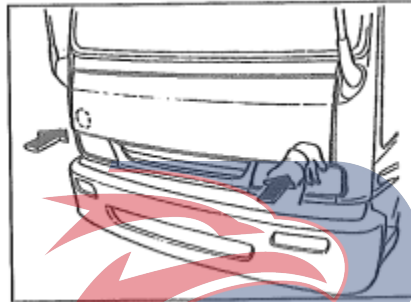
**Close:**

1. Replace the strut rods into its storage clip.
2. Lower the front cover and press down the lower two parts of the front cover as shown in the figure.

Make sure the front cover is fully locked (in two places).

Cab tilting

When servicing or checking parts in the engine compartment, tilt the cab forward as described below.

POWERSTAR

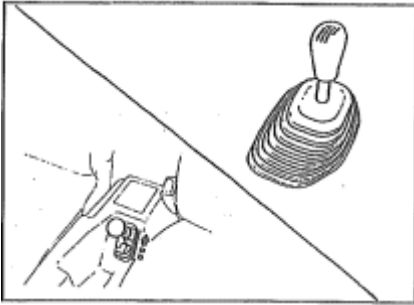

1. Prepare the cab before tipping.

- * Do it on a flat surface. Make sure there is sufficient space in front and rear of the driver.
- * Make sure that the hand brake lever or the spring brake is operated actually. If necessary, the wheels should be blocked.
- * Put the shift lever in the neutral position.
- * Stop the engine.
- * Do not leave anything pourable in the cab.
- * Close the doors on both sides securely.
- * Before lifting the cab upwards, make sure that the headlights are turned off.

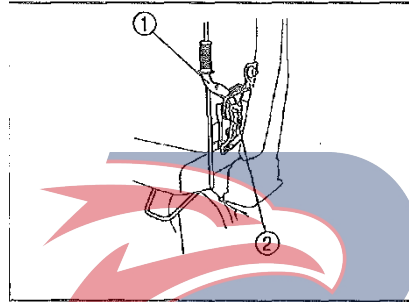

2. Remove the tilt lever locking pin ① on the left rear of the cab. Pull the tilt lever out of the locking bracket ②

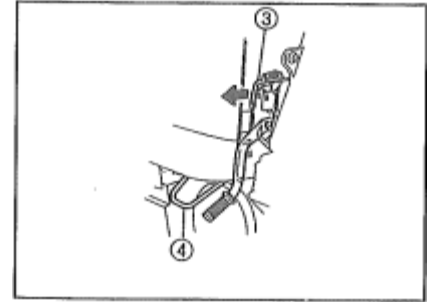

3. Then, hold the safety torsion rod ③ by one hand, and grab the cab handle ④ by the other hand, to pull out the safety torsion rod, and tilt the cab (note that the cab cannot be tilted quickly).

In addition, when the safety lever is released, it will be returned to its original position.

POWERSTAR

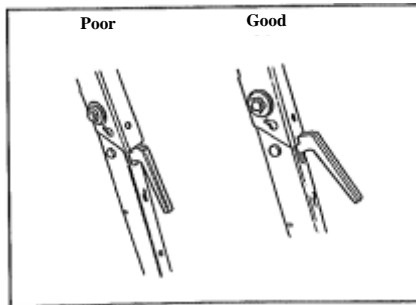

4. Support the cab tilted halfway to confirm that the cab tilt bracket is locked.

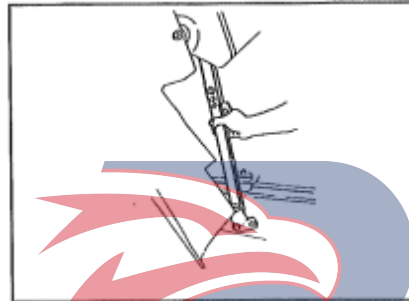

5. To lower the cab to the original position. Hold the cab tilt bracket locking lever, release the lock, pull the bracket rearward, to drop the cab; release the locking lever, hold the cab handle, and pull it down. The safety lever can be locked automatically.

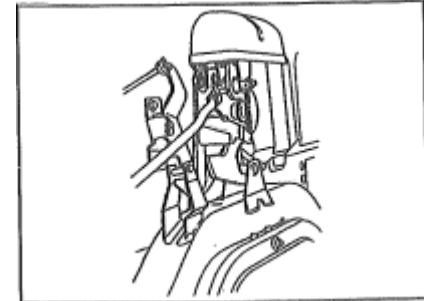

6. Push the tilt lever upward and press into the locking retainer. After confirming locking, install the locking pin.

Before driving the vehicle, it should be reconfirmed that the cab is firmly locked in the lower position of the vehicle.

POWERSTAR

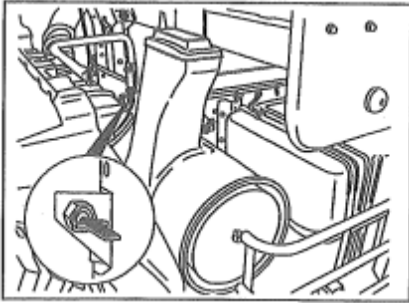

OPT Starter auxiliary switch

The starter auxiliary switch can start the engine when the cab is tilted.

Before pressing the starter auxiliary switch, check whether the shift lever is placed in the neutral position. Check if the switch is in the “ON” position and the parking brake is pulled up.

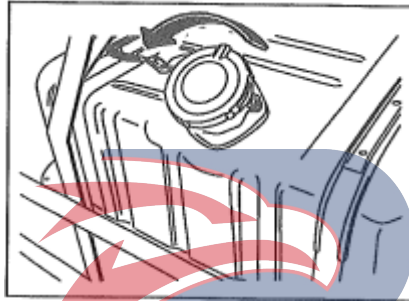

Fuel tank filler cap

Rotate the cover counterclockwise to remove it.

When unscrewing the cover, do not allow water, dust, or other foreign objects get into the fuel tank to avoid engine failure. It is important to use automotive diesel fuel in the fuel system.

Use diesel with cetane 45 or higher.

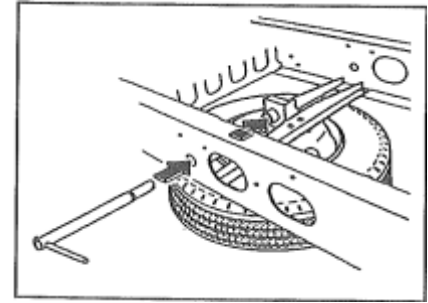

OPT Spare wheel hanger

To remove the spare wheel, insert the handle into the hole on the frame side and turn it in a counterclockwise direction.

When reinstalling, turn the crank clockwise until it stops, tighten it again and secure the tire to a fixed position.

It should be confirmed that the fixed state is secured and the spare tire does not move.

POWERSTAR

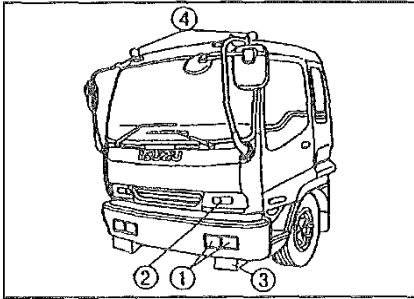

Front side

- ① Headlight
- ② Turn signal lights and vehicle width lights
- ③ Fog lights
- ④ Dome light/sign identification light

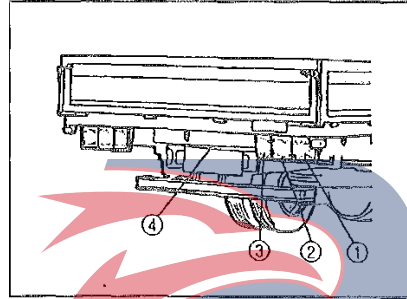

Rear side:

- ① Turn signal lights
- ② Taillights, brake lights and reflectors
- ③ Reversing lights
- ④ License plate lights

POWERSTAR



Before driving your vehicle

Proper management and driving can not only prolong the life of the vehicle, but also save fuel and grease. Be careful to drive safely. If any abnormality of the vehicle is found during the inspection, please contact the QingLing Auto Dealer.

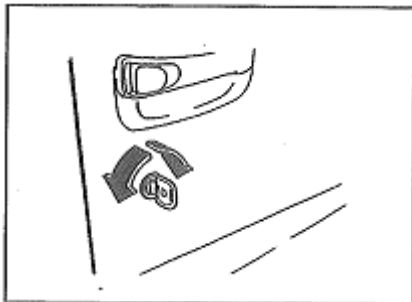

Operation control Outside door handle

Press the button on the outside of the door to lock the door and the door will open. Insert the start switch key in the keyhole on the door and rotate it to lock the door.

OPT Automatic door lock

Simply insert a key into the driver door lock and turn it to unlock or lock all the door locks.

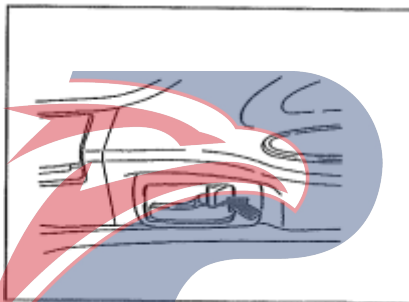

Lock the door (outside)

The door can be locked from the outside without using the key.

That is, set the door lock knob inside the door and then press the door lock button to close the door.

Do not lock the key into the vehicle.

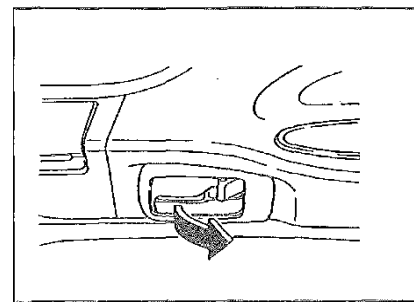

Inside door handle

Open the handle inside the door and the door opens.

POWER STAR

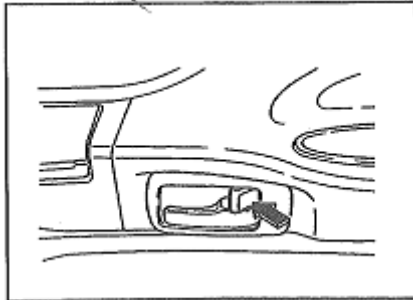

Lock the door (inside)

Close the door and press the door lock button, to close the door.

OPT Automatic door lock (inside)

After closing the door, simply push in or pull up the door lock pin on driver side to unlock all door locks.

Before the vehicle starts, it is important to note whether the door is closed and locked. Especially when children are in the cab, pay extra attention to prevent accidents.

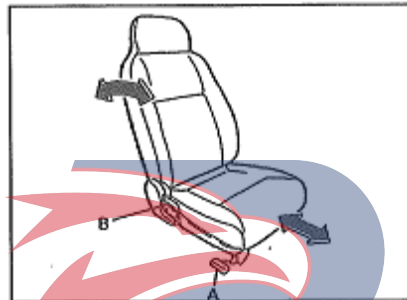

Driver's seat

Handle A: Pull up on this handle to adjust the seat position forward and backward.

Handle B: Pull this handle to adjust the tilting angle of the backrest.

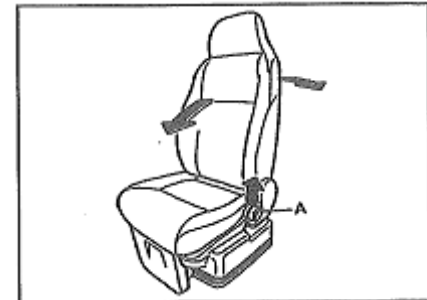

Passenger seat

Handle A: Pull this handle to adjust the tilting angle of the backrest.

POWERSTAR

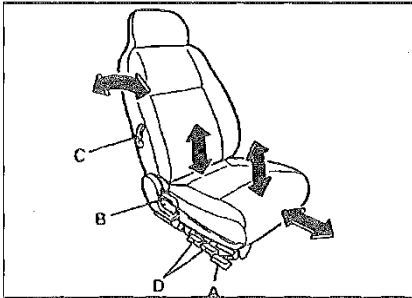

OPT Driver's seat (suspended seat)

Handle A: Pull up on this handle to adjust the seat position forward and backward.

Handle B: Pull this handle to adjust the tilting angle of the backrest.

Handle C: Pull this handle to adjust the lumbar support position.

Handle D: Pull this handle to adjust the tilting angle of the cushion.

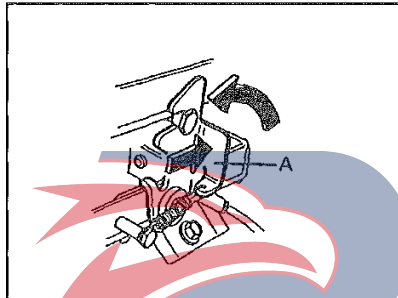

OPT Driver's seat (air suspension seat)

Air-suspension seats can maintain the required air-cushion height by air pressure under different driver weights.

Handle A: Pull this handle to lock the seat height in the middle position.

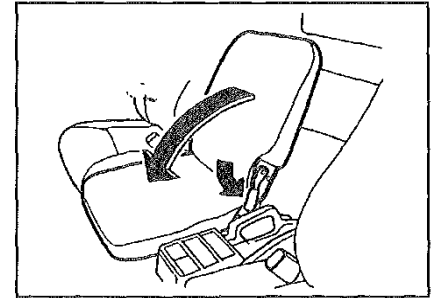

OPT Middle seat

Pull this handle to fold the backrest.

POWERSTAR

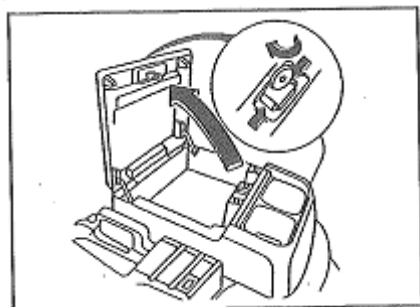

OPT Console storage box

Press the button on the cover to open the glove box on the console. Its cover can be locked with the start switch key.

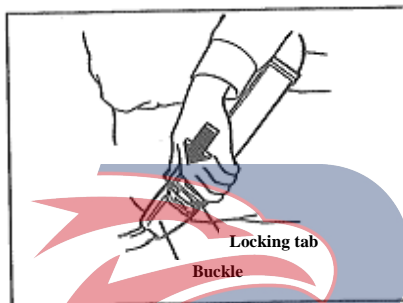

OPT Seat Belt (Safety Belt)

1. Adjust the position of the seat as required and sit on the seat so that the upper body is in close contact with the backrest.
2. Hold the buckle tab, cross the seatbelt around the body and insert the tab into the buckle. When the lock is locked in place, a "Click" sound will be sent.

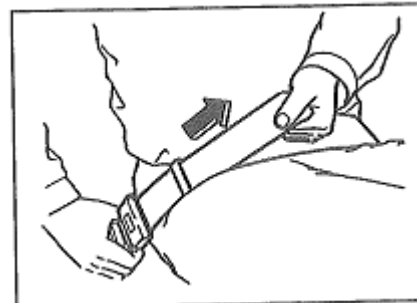

Make sure the seat belt is firmly tied to the lower buttocks, not the waist. The length of the safety belt can be adjusted by pulling on the end of the locking plate side safety belt.

POWERSTAR

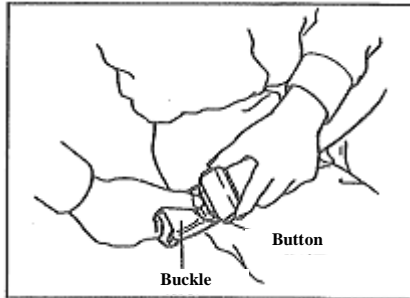

3. Press the button on the buckle to release the seat belt.

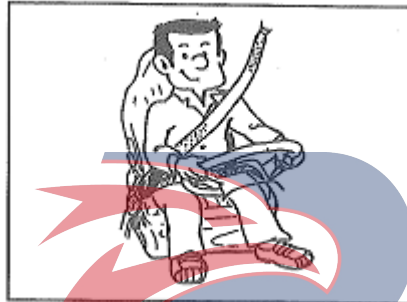

OPT Front seat shoulder-waist duplex safety belt

As an option in your vehicle, you may be equipped with a compound safety belt which is supported by three fulcrums and functions as a belt and shoulder strap.

For the method of using the seat belt described above, refer to the following information and follow it accurately.

1. Adjust the seat to the position where the driver feels comfortable. The upper body should in close contact with the back when sitting on the seat.

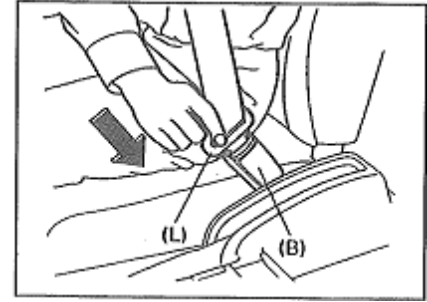

2. Hold the seat belt buckle tab (L) and pull the duplex seat belt so that it crosses over your body. At this time, the buckle tab should be pulled to the position of the buckle (B) along with the seat belt, and it should be inserted into the open end of the buckle until it is buckled with a click sound.

It is important to make the seatbelt in close contact with the body and lower it position, because the force generated from the seatbelt can be distributed on the stronger pelvis, other than on the abdomen in case of a collision. If a seatbelt is not fastened, a serious accident may cause injuries and even death.

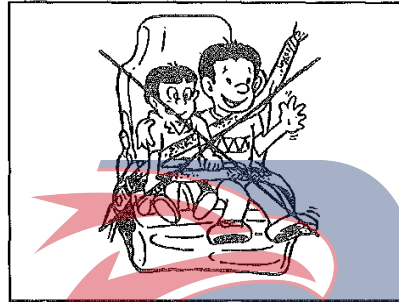

The belt across the waist should be pressed down so that it is as close as possible to the pelvic part. Then, tighten the shoulder belt that passes through the tab hole and tighten it so that it is fit closely against the waist. In this way, the risk of body slipping out of the seat belt in the event of a vehicle accident can be reduced. If the buckle (K) is pressed against the tab when the seatbelt is tightened, the buckle should be moved toward the door.

In order to avoid any injury in case of an accident, two persons can not wear one seatbelt at the same time. Attention shall be paid to avoid the seatbelt wear due to being twisted or being trapped by the seat metal components or caught by the door.

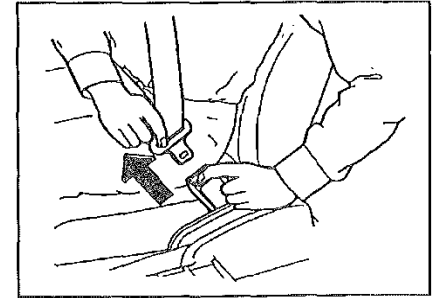

A so-called “vehicle sensing retraction device” is installed on the shoulder portion of the front seatbelt. The design feature of this device is that the safety belt is only locked in the event of a sudden stop or vehicle collision, while in the rest of the case the seat belt can follow the wearer's movement to slide. Press the button on the buckle to release the seat belt.

If not used, the safety belt can be taken into the retraction device and stored. If necessary, the positioning buckle on the seatbelt can also be moved to allow the seatbelt to be drawn into the retraction device. At the time, the buckle tab can be placed on the accessible door pillar.

POWERSTAP



Seat belt inspection and care

- Check the safety belts, buckles, buckle tabs, retraction devices, and seats regularly for damage, so as not to reduce the safety effect.
- Any item with sharp edges and that cause any damage should not be placed near the seatbelt.
- If the seat belt is found to have been cut, weakened, cracked, or subjected to a collision load, replace it.
- Check that the set bolts are tightly fastened to the floor.

- Any failed part must be replaced.
- Seat belts shall be kept clean and dry.
- Only use weak alkaline soap and warm water for cleaning.
- The seat belt must not be bleached or stained, as this will weaken the strength of belt.

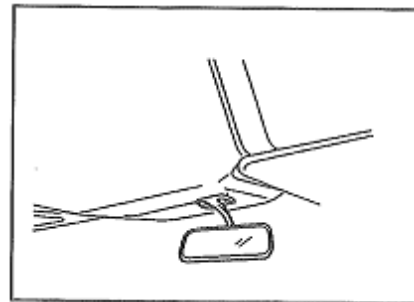

Mirror

Interior rearview mirror

Move the rearview mirror up and down or left and right to adjust its position.

POWERSTAR

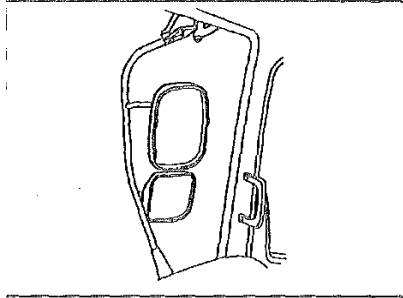

Outside rearview mirror

Adjust the rear view mirrors, so that the scenes on both sides of the rear road and the conditions on both sides of the rear trunk can be seen. It can help you to determine the relationship with the rear object.

OPT Down/Side Mirror - Down Mirror

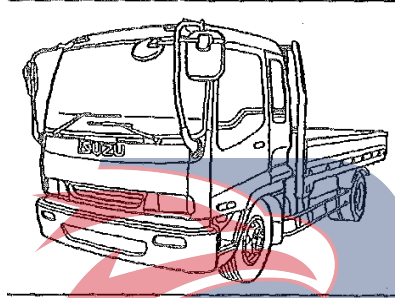

Driver checklist (daily check)

To ensure safe and reliable driving, the following items should be checked. (Refer to "MAINTENANCE GUIDE" for proper check-up procedures)

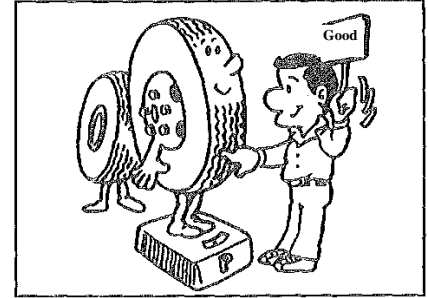

Outside

1. Check tire pressure and damage.

POWERSTAR

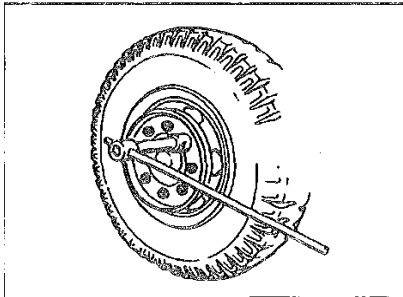

2. Check whether the wheel nuts are loosened.
8 hub bolts:

The nuts on the right wheels should have positive thread
The nuts on the left wheels should be reversely threaded

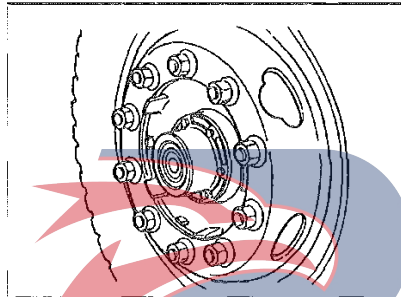

3. Check the oil level in wheel bearing.
(If equipped)

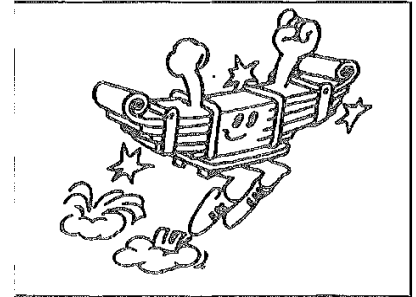

4. Check whether the chassis springs are damaged.

POWERSTAR

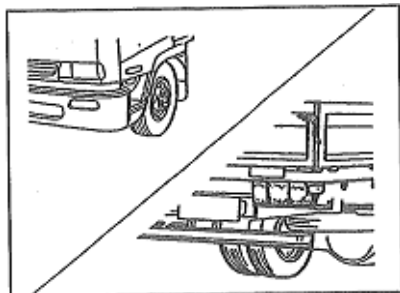

5. Check the lights for normal operation.

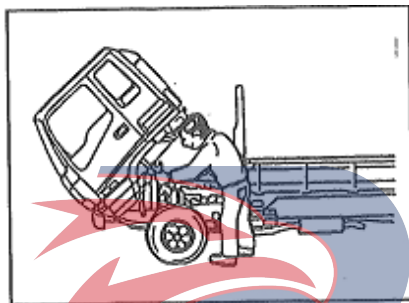

6. Check all parts of engine oil, coolant, fuel, and power steering fluid for leakage.

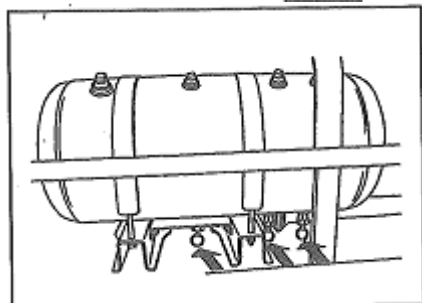

7. Drain the water from the air tank.

POWERSTAR

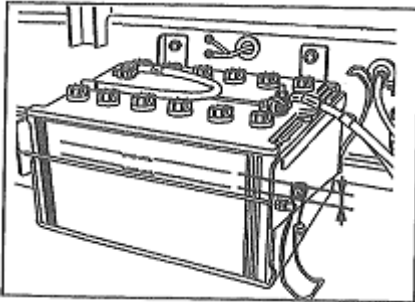

8. Check the electrolyte level in each battery cell.

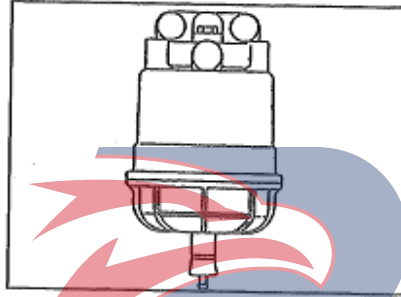

9. Check the water level in the water separator.

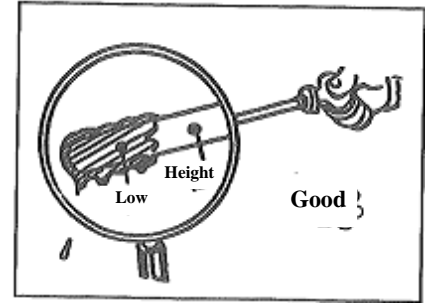

Inside the engine compartment

1. Check the engine oil level.

POWERSTAR

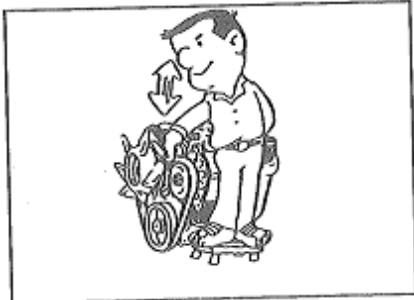

2. Check the tension of fan belt.

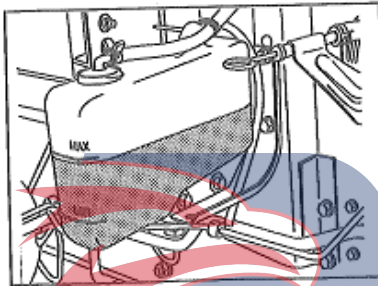

3. Check the level of engine coolant and cover the water tank.

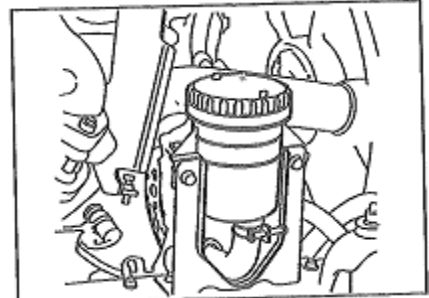

4. Check the power steering liquid level.

POWERSTAR

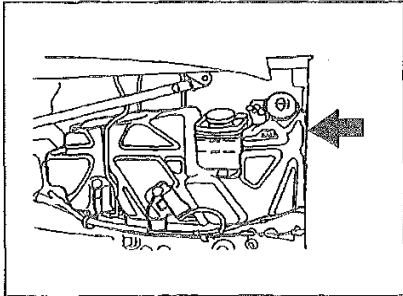

Inspection of inside of front cover

1. Check the level of the cleaning fluid in the windshield washer reservoir.

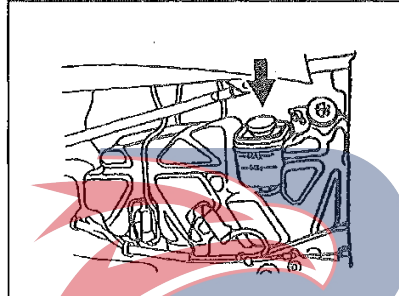

2. Check the liquid level of the clutch fluid in the reservoir.

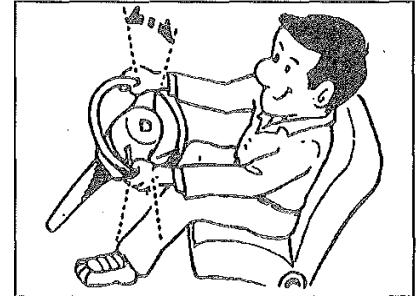

Inside the cab

1. Check the steering wheel for free stroke and stability.
The free play of the steering wheel should be checked with the engine rotating.

POWERSTAR

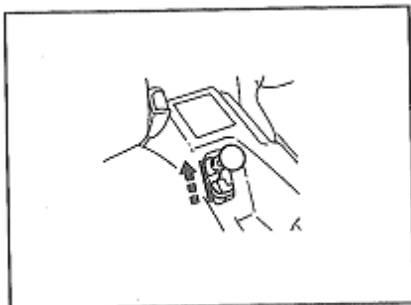

2. Check the parking brake lever for stroke.

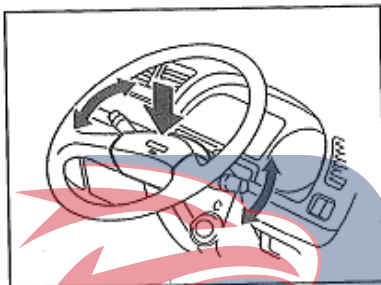

3. Check if the horn, windshield wiper and turn signal light can be used normally.



4. Check the instruments and indicators.

POWERSTAR

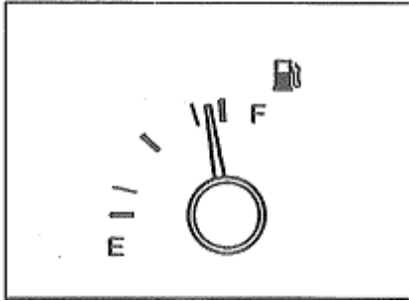

5. Check the fuel level in the fuel tank.

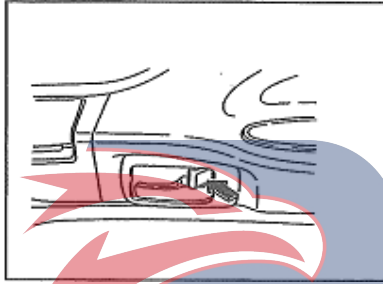

6. Check the condition of the door lock mechanism.

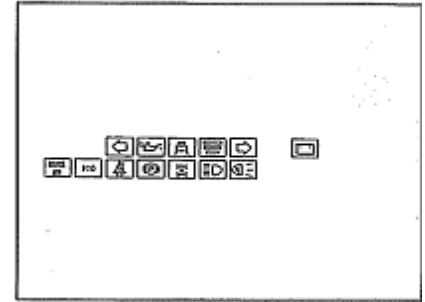

After starting the engine

1. Check whether the indicator lamp goes out and stays off when the engine is turning.

POWERSTAR

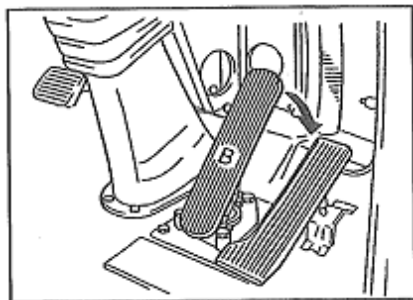

2. Check free play and stepping condition of brake pedal.

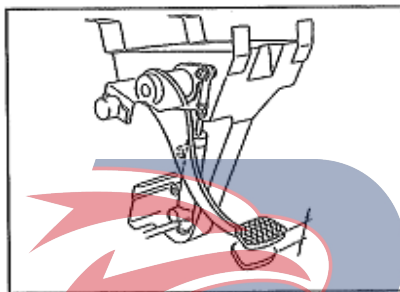

3. Check the free play, stroke, and function of clutch.

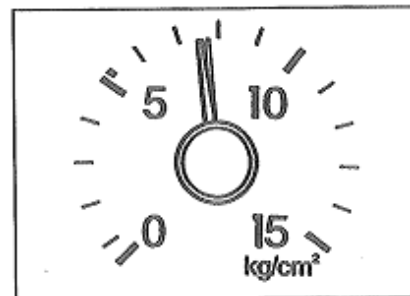

4. Check the inflation air tank.

POWERSTAR

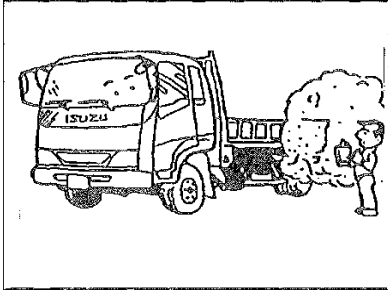

5. Check the abnormal engine noise and abnormal exhaust color and odor.

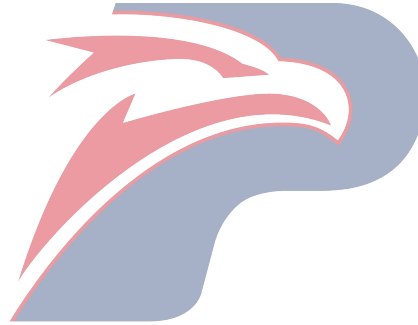

POWERSTAR



Driving

Proper maintenance and driving not only extends the life of the vehicle, but also helps to improve the economics of oil and fuel.

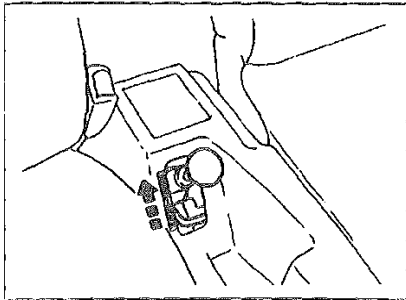

Preparations before starting the engine

1. Pull up the parking brake lever.

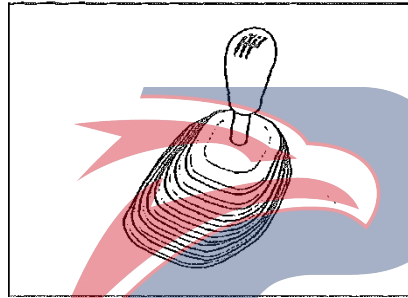

2. Place the transmission in neutral.
Please refer to the neutral position shown on page 25 of this book.

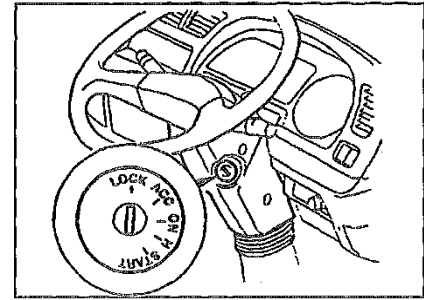

Engine start:

When the outside temperature is below 0°C, or when on high land with height of 1,500m

1. Turn the start switch key to the “H” position and hold it in this position until the control resistor becomes red hot.

When the engine is hot:

1. Turn the start switch key to the “ON” position and then depress the clutch pedal and accelerator pedal to the bottom.

POWERSTAR

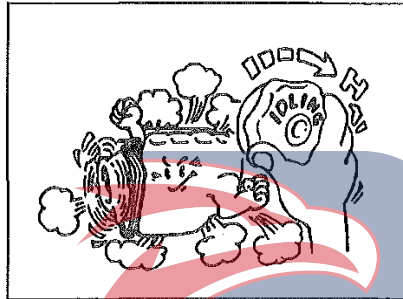

Turn the start switch key to “ON” position and then depress the accelerator switch. If the accelerator pedal is depressed with the start switch key in the “LOCK” or “ACC” position, the engine will be difficult to start.

2. Turning the starter switch key to the “START” position will start the engine.

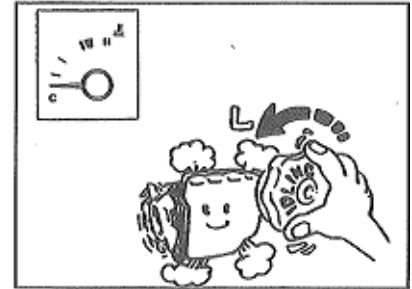

When the engine is preheated safely, turn the idle control knob back to the normal idle position.

POWERSTAR

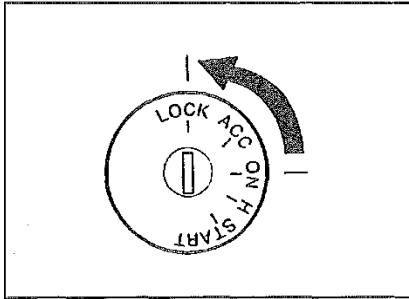

Stopping of the engine

1. Turn the starter switch to the “LOCK” position.

If the engine tends to overheat, do not stop immediately and perform cold operation temporarily.

Operation of turbocharged engine General precautions

If the naturally aspirated engine is replaced with a turbocharged engine, the engine performance can be improved, but the same allowable axle load and allowable vehicle gross weight must be maintained. Overloading and extension of the rack must be avoided, otherwise it will not only cause danger, but also lead to premature wear and damage of parts and components.

Normal start of the engine

When starting a turbocharged engine,

make ensure the bearing cage and rotating parts of the turbocharger are fully lubricated and that the engine in the cold status cannot be operated at high speed.

Stop the engine

After driving on the road, operate the engine at idling speed for at least 3min until the engine is cooled down. In the way, the turbocharger can be returned to idle speed, and the oil pressure can provide the full lubrication, so as to extend the service life of the turbocharger bearing.

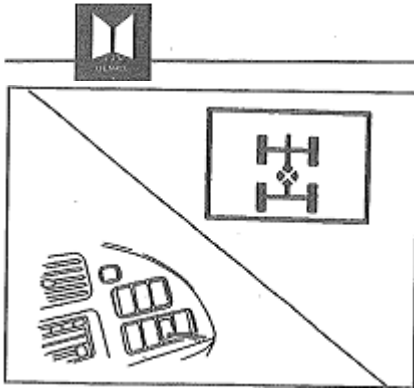

FVZ Operation of intermediate differential locking device

If any of the wheels on the axles of the rear axle begins to slip due to plunging into muddy, sandy or snow ground, the middle differential locking device can be operated by the following method, so that the vehicle can obtain sufficient traction to get out of the wheel slippage status.

1. When any of the wheels of the rear two axles slips, stop the vehicle immediately.
2. Press the middle differential lock switch and confirm that the middle differential lock indicator turns on.

3. Be careful about starting the vehicle

When the middle differential locking device is started successfully and the two shafts of the rear axle are directly connected, the torque of the engine can be directly transmitted to the wheels which do not slip, so that the vehicle is out of the slip state.

4. After the vehicle comes out of the place where the wheel slips, stop the vehicle and press the middle differential lock switch again and confirm that the indicator lamp of middle differential lock turns off.

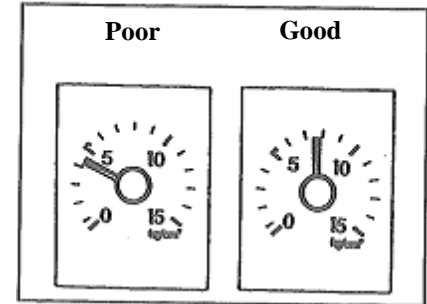

Before driving off

According to the formal inspection procedures, it is necessary to thoroughly check whether the systems are working properly.

1. When the air pressure is found to be lower than 5.3 kg/cm², avoid starting the vehicle.

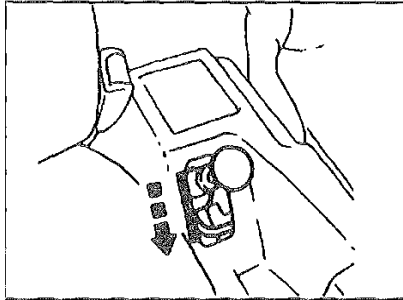

2. Full release the parking brake

Place the gear shift lever in 1st gear and carefully start the vehicle; do not quickly release the clutch pedal and make the engine over speed.

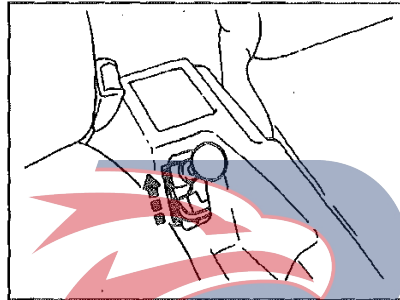

Parking

1. Switch the gear lever to the neutral position and apply the parking brake. When the driver leaves the vehicle on a slope, fix the wheel to prevent the wheel from slipping.

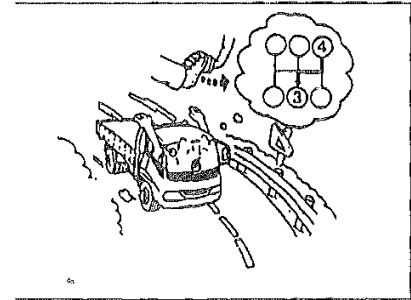

Driving precautions

1. Avoid the engine over speed.

Special care should be taken when driving downhill to prevent overspeed of the engine. Especially when shifting into low gear, the engine can easily overspeed.

POWERSTAR

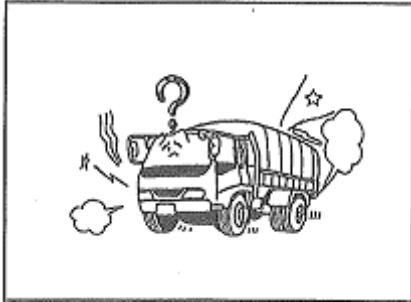

2. When driving, if abnormal sound or odor is found, stop and check to find out the cause of the problem.

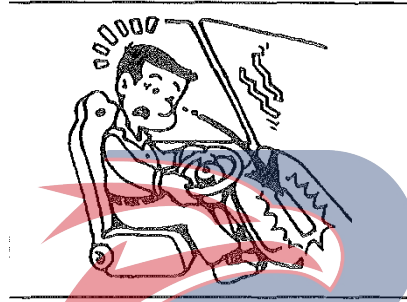

3. During driving, if it is found that the indicator lamp or the instrument has a normal phenomenon, stop for inspection and find out the cause of the malfunction.

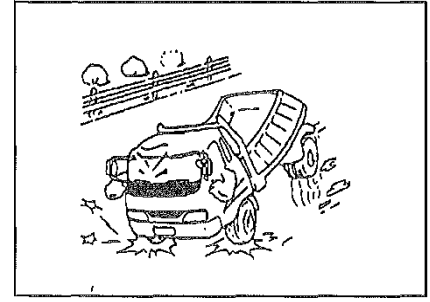

4. Avoid unnecessary acceleration and sudden braking.

POWERSTAR

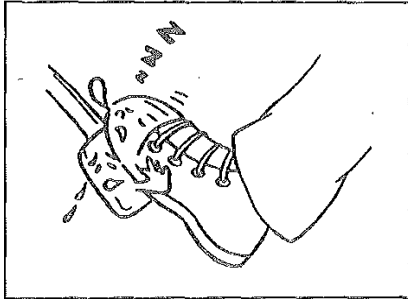

5. When driving, do not rest your feet on the clutch pedal; otherwise, it will create a partial release, resulting in premature wear of clutch friction linings.

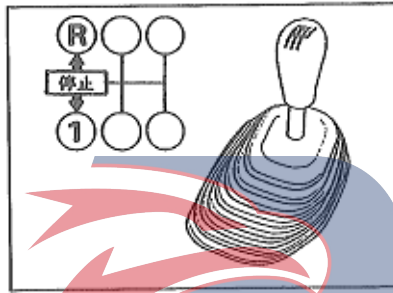

6. Stop the vehicle completely before moving from forward gear to reverse gear or from reverse gear to forward gear.

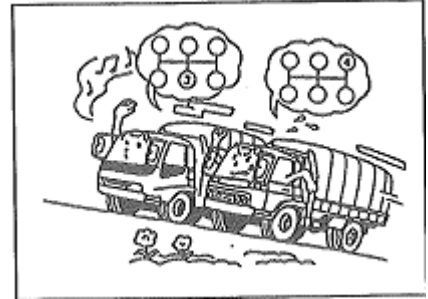

7. When a large traction is required on an uphill, the low-speed gear should be switched to reduce the engine overload.

POWERSTAR

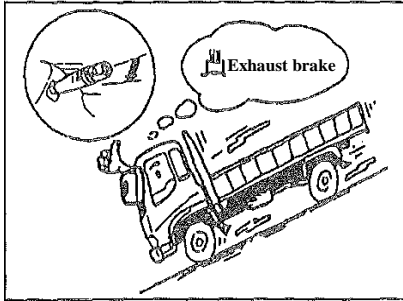

8. When driving down a long slope, the engine brake, foot brake and exhaust brake should be used in combination at the low gear. Only and continuous use of foot brake may induce air resistance and brake failure. It is easy to slip in rainy days when braking, and good results can be achieved by using exhaust brake.

* When the transmission is in the neutral position, it does not work even if the exhaust brake switch is turned on.

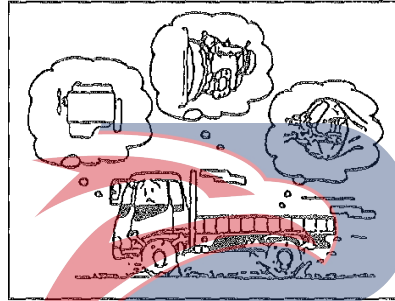

9. When the vehicle is driven through a shallow river or puddle, must pay special attention to avoid that any water enters the exhaust manifold; otherwise it may cause serious damage to the engine.

After the vehicle is driven through a river, must check the various parts of the engine, rear axle and transmission for grease and oil conditions.

If there is any water, must clear the water and add the specified oil.

After crossing the river, depressed the brake pedal several times to allow the brake shoe to dry.

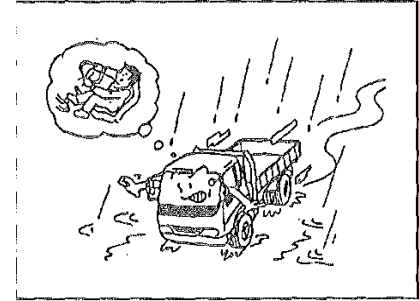

10. In heavy rain, pay special attention to safety. Because the brake is wetted with water, the brake force will be temporarily reduced.

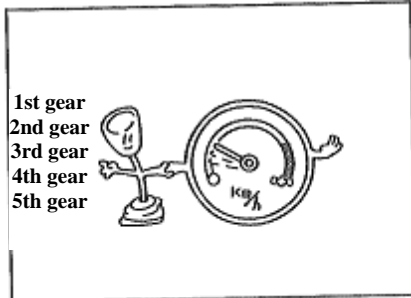

Driving for economy

1. Unnecessary high-speed driving and low-speed driving in high-gear positions will increase fuel consumption.

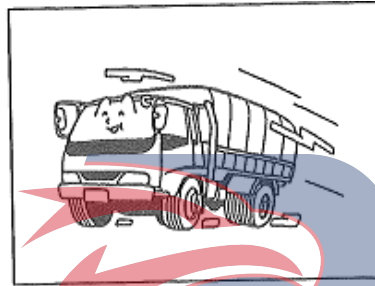

2. At high gear or overdrive gear, the driving speed should be stable.

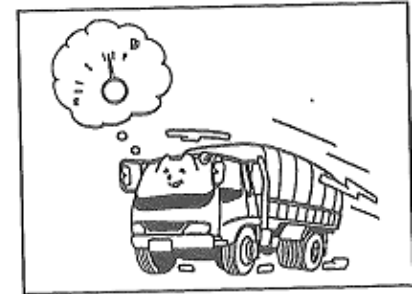

3. When driving, keep the coolant temperature within the normal range.

POWERSTAR

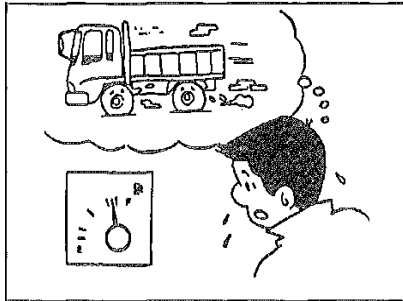

4. Inflated tires will reduce fuel economy.

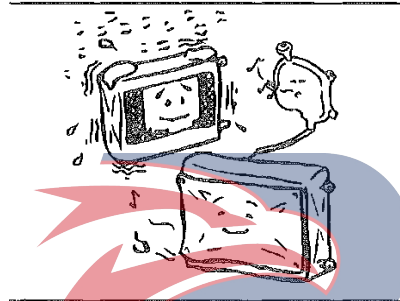

Precautions about driving in winter

Prevent engine from overcooling

Undercooling not only wears out the main parts of the engine, but also reduces fuel economy.

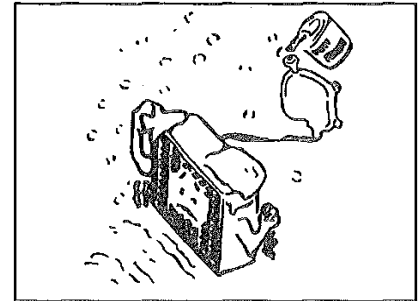

Use of antifreeze

The freezing temperature will change with the mixing ratio of antifreeze and water.

POWERSTAR

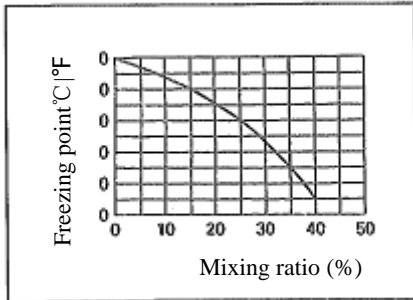

1. The appropriate mixing ratio of high-quality glycol-based antifreeze can be determined according to the graph shown on the left. It is the responsibility of the user to maintain the amount of antifreeze fluid that corresponds to the ambient temperature of the area where the vehicle is used.

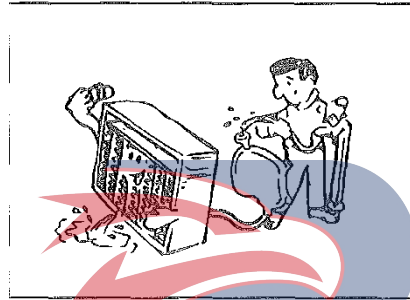

2. Before using antifreeze, clean the engine cooling system thoroughly including the radiator.
3. Damaged hoses should be replaced in advance, and antifreeze can leak from even tiny gaps.

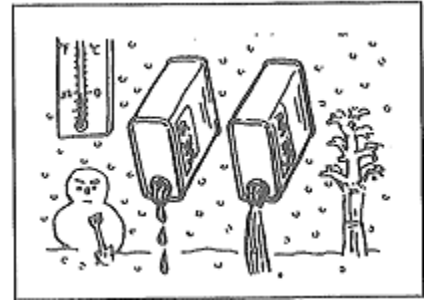

Engine lubricating oil

When the temperature is decreased, the oil viscosity will be increased. Use a lubricant with a viscosity suitable for the air temperature.

POWERSTAR

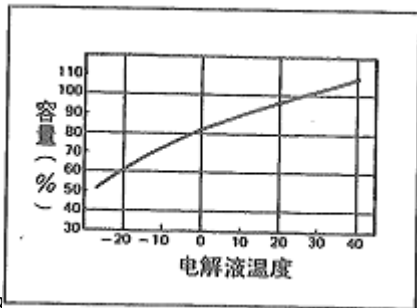

Battery

When the ambient temperature is decreased, the battery capacity will be decreased. In addition, as the discharge decreases, the specific gravity of the electrolyte decreases. Therefore, the measures must be taken to prevent the battery from freezing.

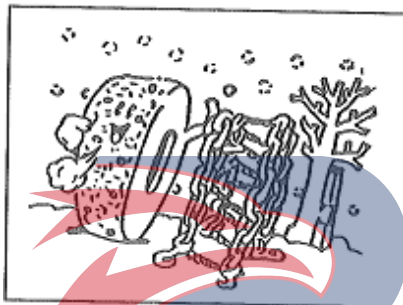

Driving on snowy or frozen roads

1. When driving on snowy or frozen roads, please use the tire chains or snow tires.

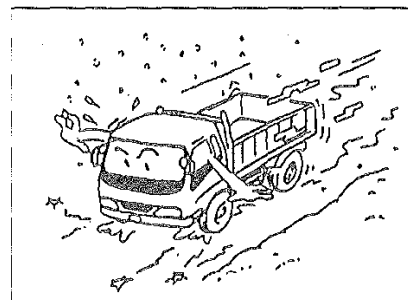

2. On snow or frozen roads, avoid high speeds, sudden acceleration or sudden braking and sharp turns.

POWERSTAR

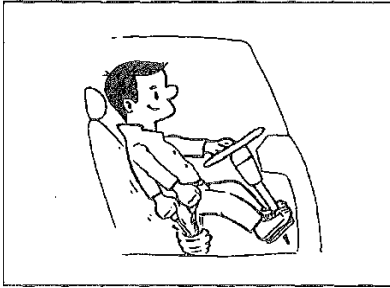

3. Use a low gear to achieve engine braking effect.

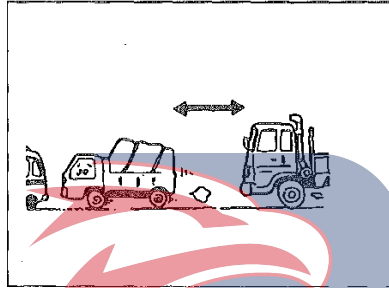

4. Pay attention to maintain the proper distance between the vehicles.

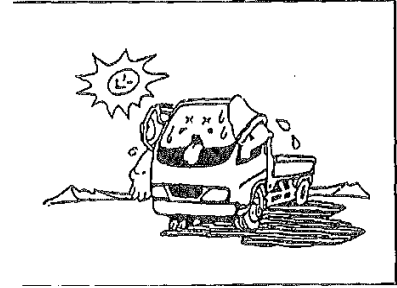

Precautions for vehicle use in tropical area

At high temperature, the engine may be overheated. Please implement the operations with the methods as described below to avoid overheating of the engine.

1. Do not use hard water such as well water or river water in the cooling system of the generator. In order to prevent accelerating the accumulation of rust and scales.

POWERSTAR

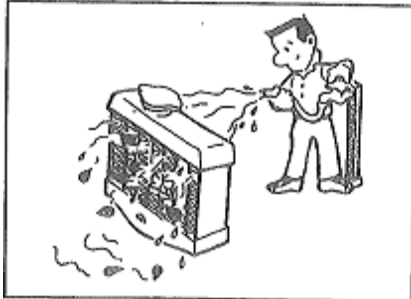

2. Insects, dirt, or other obstacles remaining in the air ducts of radiator, can degrade the performance of cooling system. Always check the air ducts for clogging and clean them with water of less high pressure.

3. The consumption of electrolyte fluid will increase at high temperatures. Always check the electrolyte level and, if necessary, fill the electrolyte.

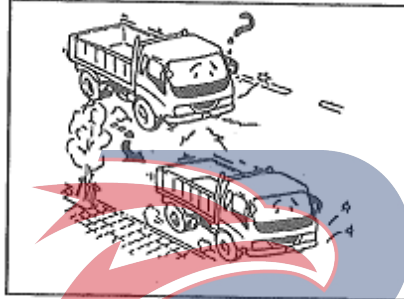

In case of an emergency Emergency stop

1. For some reasons, if necessary, the vehicle should be kept on the right (or left) away from the traffic lane and should not be parked on the traffic lane.

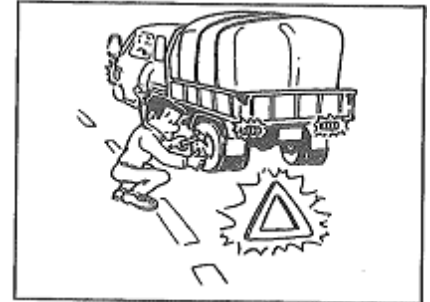

2. After the parking brake or spring brake is applied, the hazard warning lamp must be flashed regardless of day or night.

POWERSTAR

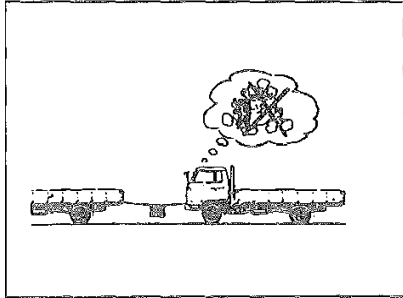

Emergency starting

1. Try to avoid starting the engine when it is towed by another vehicle, which is easy to cause a crash with the towing vehicle.

2. If the battery is fully discharged, replace it with another auxiliary battery with the same voltage as the original one of 24 volts. Carefully operate the batteries, so as to avoid any accident due to battery explosion; an acid fire and electric spark may cause injuries and even death or damage to the vehicle or electrical equipment.

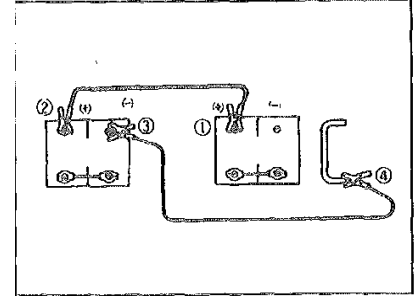

Cable connection steps

The engine can be started with another vehicle battery using the jumper cables.

1. Vehicles equipped with batteries of the same rated voltage (24 V) should be used.

2. Connect jumper cables in the following order.

- ① Positive terminal of the dead battery
- ② Positive terminal of the booster battery
- ③ Negative terminal of the booster battery
- ④ Chassis ground wire equipped with discharged battery, and ground wire shall leave discharged battery as far as possible.

POWERSTAR



3. After connecting the jumper cable, start the engine of the vehicle with the auxiliary battery.

4. Slightly increase the engine speed of the vehicle equipped with auxiliary power storage and then start the engine of the vehicle with the battery has been fully discharged.

5. After starting the engine, remove the jumper cable in the reverse connection order.

Never connect the cable between the positive and negative terminals. Do not remove the cables from the terminal posts while the engine is running, otherwise the fault in the electrical system may be caused.

Towing

If the vehicle you are driving is unable to be driven due to a fault, you must request the QingLing Motor Company's special dealership repair shop or a special fault vehicle haulage service company for towing service so as to prevent damage to the towed vehicle. At this time, the proper towing device must be used and the local rules and regulations that apply to the towed vehicle shall be complied with. Towing speed must not exceed 40 km/h within a towing distance of 10 km.

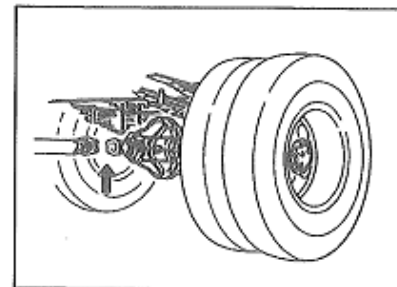

1. Front-end towing

All wheels are in contact with the road or the front wheels are suspended from the ground. If the steering mechanism of the faulty vehicle is operated normally, all the wheels can be used for traction. However, do not forget that the power steering mechanism has lost its boosting effect at this time. If the compressed air has already leaked, the brake of the faulty vehicle can no longer be functional. A towing bar must be firmly installed between the towing vehicle and the faulty vehicle.

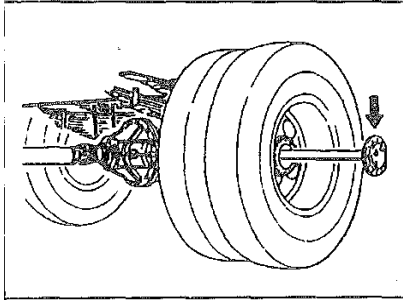

The parking brake should be released with the method described in “Air Parking Brake” below (see Section 3). Disconnect the drive shaft from the rear axle and fix it on the frame or frame crossbeam.

If the rear axle is damaged or suspected to be damaged, the shaft of the rear axle should be disassembled. At this time, cover the opening of the hub with a blind plug or the like to prevent the loss of grease and foreign matter from entering the interior.

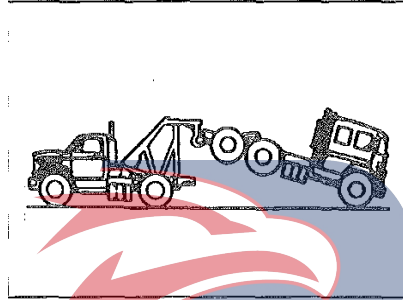

2. Rear-end towing

(Rear wheels off the ground)

The steering wheel of the faulty vehicle should be fixed at a straight forward driving position.

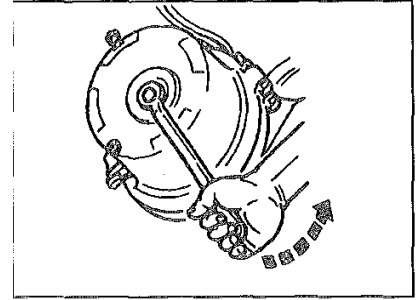

3. If the compressed air pressure is found to be reduced, manually release the rear axle spring brake. The brake should be exhausted manually with the operation steps below.

(JKC mode)

Use a wrench to turn the nut of release bolt a few turns to remove the release resistance of brake. When the bolt extends approximately 70 mm, the spring brake is released.

POWERSTAR

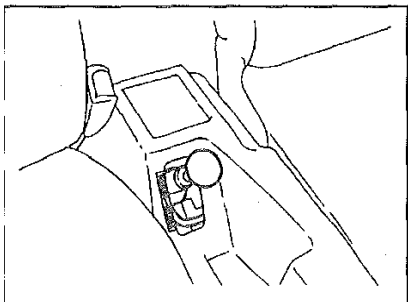

OPT Wheels parking brake

In case of emergency:

If the pressure of the compressed air in the air tank drops, must enable the brake valve to release the wheels and disable the brake.

In the above case, release the wheel parking brake as follows.

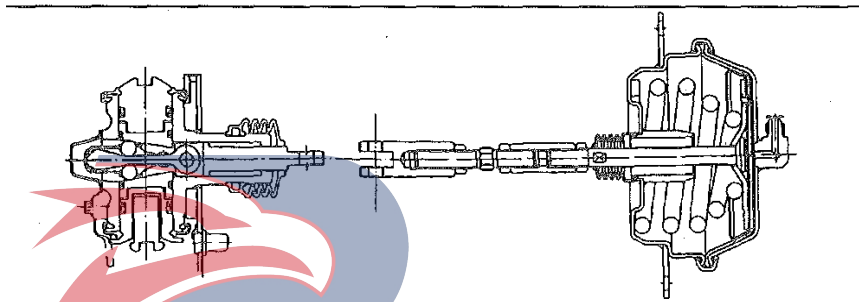

POWERSTAR

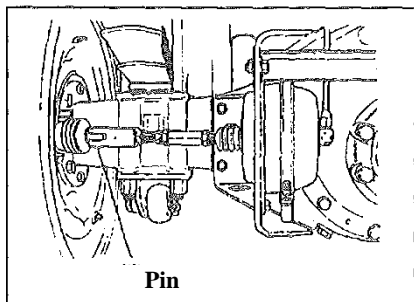

Release and apply the parking brake in emergency case

Rotate the rigging screw that connects the wheel cylinder and the push rod of the power chamber to extend the push rod until the wheel can rotate freely.

Restore

1. Remove the locking pin from the claw joint to separate the push rod.
2. Fill the power type device with compressed air with a specified pressure value.
3. Pull out the push rod on the wheel cylinder side by hand and rotate the elastic screw to shorten the push rod to an appropriate length. Install the claw connector and insert the locking pin.

Note: If you inflate the power chamber before disassembling the push rod, the wheel cylinder will be damaged.

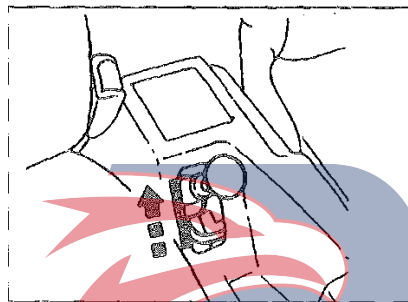

Instructions for placing jacks and replacement of flat tire

Precautions:

1. Park the vehicle on a level surface and set the parking brake.
2. Put the danger indicator into working condition.
3. Tilt the tires to the diagonally opposite of the jack mounting position.

When supported by jacks only, do not go under the vehicle.

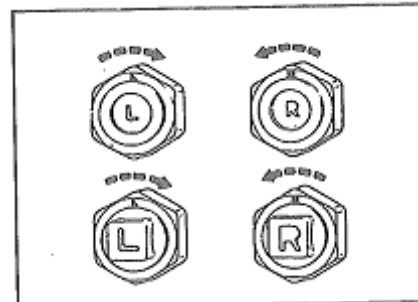

4. Loosen the nut, but do not remove the nut from the wheel.

8 bolt hub.....

The nuts on the right wheels should have positive thread. The nuts on the left wheels should be reversely threaded.

POWERSTAR

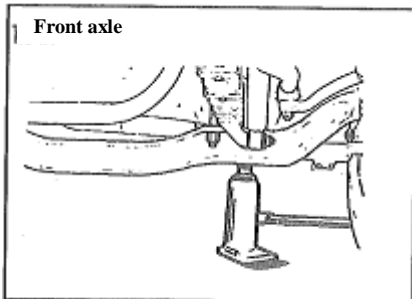

5. Place the jack on the recommended supporting point.

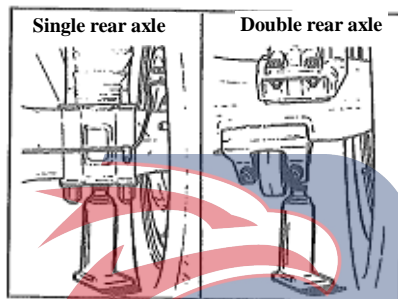

If the tyre is deflated and the tyre needs to be replaced, the jack cannot be put into the front axle by the defined fulcrum. Instead, the square timber must be placed under the front axle in advance according to the following method.

POWERSTAR

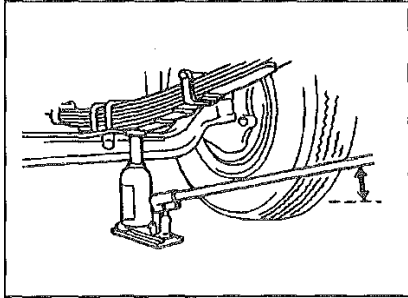

1. Apply the parking brake to the end, and firmly fix the wheel on diagonal side of the specified jack point.

2. Put the jack under the leaf spring at the front of the front axle and lift the front axle. At this time, it should be confirmed that the jack has reached the position where it can lift the front axle.

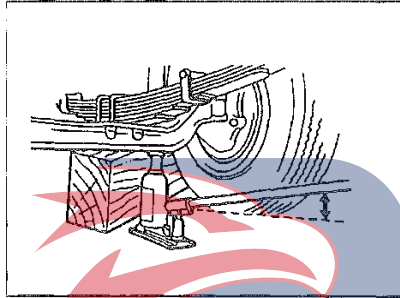

3. Insert square wood under the front axle. After confirming that the front axle is supported with a square wood, remove the jack from underneath the leaf spring.

4. Move the jack under the specified fulcrum and raise the front axle again, to where it is sufficient to disassemble the flat tire.

If the bottom of the leaf spring is bent, special care should be taken to jack the front axle.

In order to ensure the stability of the vehicle in the jack-up, square wood with the largest possible size should be used.

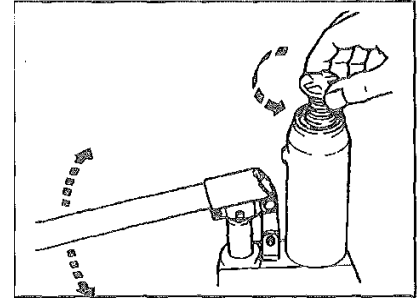

Usage of jack

To jack up:

If the top fulcrum of the vehicle is higher than the head of the jack, the head of the jack should be turned counterclockwise to extend it.

As shown in the figure, insert the jack handle and move it up and down.

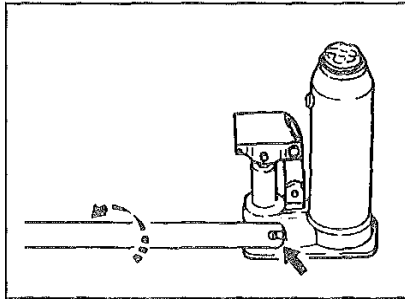

To lower:

With the jack handle is under the status as shown in the figure, slowly turn it counterclockwise to unscrew the vent screw.

Do not jack the vehicle on a slope or soft ground. Otherwise it will cause great danger.

The vehicle shall not be lifted in any other location than the prescribed jacking fulcrum.

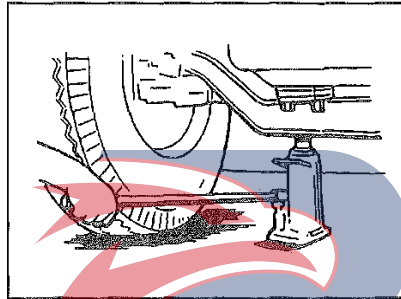

Tire replacement

1. Jack the wheels, remove the wheel and nuts, and install the spare wheel.

When replacing a wheel, you must disassemble and install it with the tire nozzle facing down.

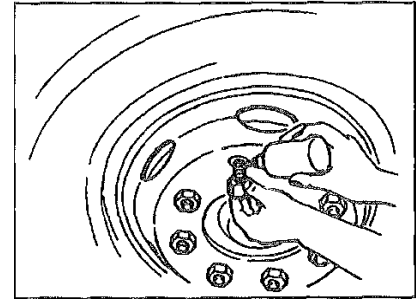

2. Clean the wheel locks and nuts and apply engine oil to the threads. Screw the nut of the wheel to a semi-tight state, and then put the wheel on the ground.

When replacing the outer wheel, check if the screw pin and of the inner wheel is loose.

POWERSTAR

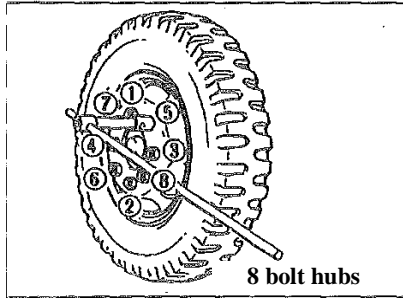

3. Fasten wheel nuts in order using wheel wrenches. As shown on the left.
8 bolt hubs: $588 \pm 49\text{N.m}$

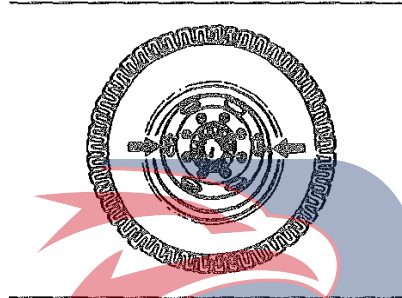

4. When installing the rear tires, adjust the tire inflation valves on the inner and outer wheels to a position that facilitates inflation of the tires.

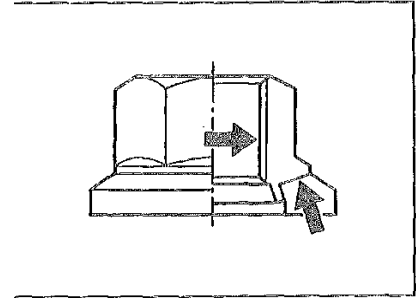

ISO8 stud wheel disc

1. Apply the oil or equivalent in the wheel nut holes and between the nuts and washers.

However, there must be no oil on the other side of the gasket.

2. Tighten the nuts of the vehicle after receiving a new vehicle or replacing the tire. After travelling 50 ~ 100km, retighten the wheel nuts to the specified torque value.

Wheel nut torque

ISO8 studs: $588 \pm 49\text{N.m}$,

3. Insert your finger deep into the opening between the centering lug and the wheel and apply multi-purpose grease or chassis grease. Apply grease after tightening the wheel nut completely.

POWERSTAR

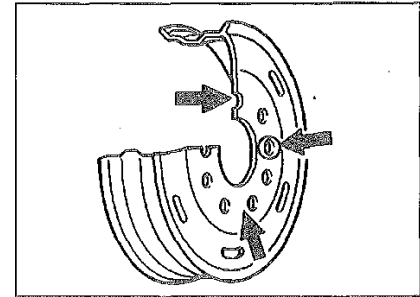
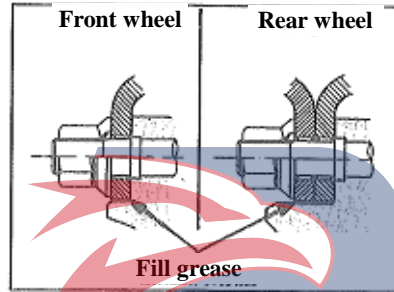
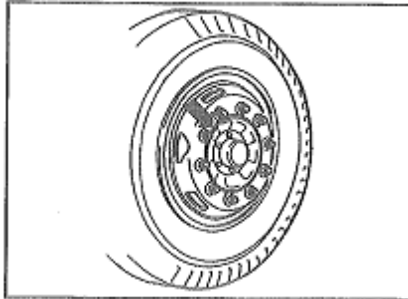

4. Do not paint the contact surfaces of hubs, wheel nuts, and dual tires. If it is necessary to paint on these surfaces because of special needs, spray them with a spray gun until you can't see the surface primaries.

If the paint film is too thick, the wheel nuts may be loosened.

POWERSTAR

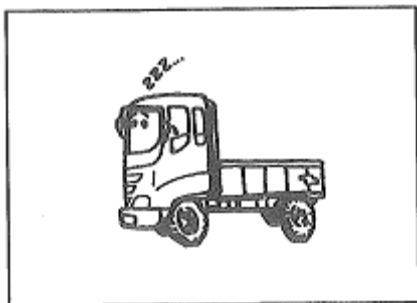

Long-term storage

During the initial test run after a long period of storage (6 months or longer), parts and components of engine and chassis would have a tendency to bite. Therefore, the engine should be started as follows.

1. Check the level of engine oil and engine coolant.
2. Pour 3-5 ml of oil into the injector or incandescent plug hole.
3. Engage the engine for 20 seconds without a fuel injector or incandescent plug hole.
4. Install the injector or incandescent plug hole.
5. Start the engine and let it idle for more than 20 minutes.

Caution

1. Avoid making the engine run at a fast idle speed immediately after starting it. After the engine is started, the vehicle should be moved forward or backward for a short distance to lubricate the gears in the transmission and the differential.
2. For information on chassis components (such as, transmission, differential, transmission, and other devices) not included on the page, please see "Driver Checklist" on Page 43 of the user manual.

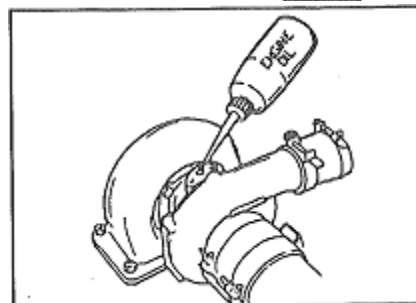

To start the parked engine for a long time, follow the steps below.

The oil is injected into the turbocharger through an oil inlet equipped with an intake pipe and a hose at the inlet side of the oil inlet. Then the impeller is rotated by hand to lubricate the bearings. During filling and draining processes, care must be taken to prevent dust and other foreign matter from entering the booster through the filler port. After completing these operations, reinstall the piping and intake manifold.



Services and Maintenance

In order to maintain safety and economical efficiency of driving, regular inspections and repairs should be carried out in accordance with the recommendations presented in this chapter.

Maintenance schedule

In order to ensure the safety and economy of driving, it is necessary to carry out regular inspections and repairs in accordance with the maintenance schedule.

For special repair tools, please contact QingLing Motors dealers.

Maintenance operations:

I: Check, clean, correct or replace as needed.

A: Adjustment.

R: Replace.

T: Tighten to the specified torque.

L: Lubricate.

When checking the following items, check the regular items together.

* Symbol: Driving under harsh and difficult conditions requires regular maintenance. Refer to the “Maintenance schedule for driving under harsh conditions”.

The logo for POWERSTAR, with 'POWER' in blue and 'STAR' in red, both in a bold, sans-serif font. A stylized eagle head graphic is positioned above the text, facing right.

POWERSTAR



Maintenance schedule (No.1)

I: Inspect, clean up and repair as necessary A: Adjust R: Replace T: Tighten to specified torque L: Lubricate
Use odometer reading or period, whichever comes first.

Service interval	×1,000 km Or monthly	Initial	Every driving	8	12	24	48
		1	4 1	2	3	6	12
Engine							
Engine start and abnormal noise		-	I	-	-	-	-
Idle and gear change		-	I	-	-	-	-
* Air cleaner element			Repeated cleaning 6 times R) or R				
Intake exhaust manifold		T	-	-	-	-	T
Valve clearance		A	-	-	-	-	A
Compression pressure of each cylinder		-	-	-	-	-	I
Oil pollution		-	I	-	-	-	-
* Engine oil		R	I	-	R	-	-
*Main shunt oil filter (combined)		-	-	-	R	-	-
Main fuel filter (sleeve type)		-	-	-	-	R	-
Oil pre filter element		-	-	-	-	R	-
Fuel tank interior		-	-	-	-	-	I

POWERSTAR



Maintenance schedule (No.2)

I: Inspect, clean up and repair or replace as necessary A: Adjust R: Replace T: Tighten to specified torque L: Lubricate
 Use odometer reading or period, whichever comes first.

Service interval	×1,000 km Or monthly	Initial I	Every driving						
				8	12	24	48		
			4 1	2	3	6	12		
Injection pressure and spray condition of nozzle		-	-	-	I	-	-		
Fuel timing		-	-	-	-	I	-		
Oil pump filter		-	-	-	-	I	-		
Air compressor and regulator and drain valve skills		-	-	-	-	-	-	I	
Radiator and water tank cap functions		-	I	-	-	-	-	-	
Loss of fan belt		I	I	-	-	-	-	-	
* Exhaust piping and installation		-	I	-	-	-	-	-	
Radiator coolant (*1: PT-type antifreeze)		-	-	-	-	-	-	-	
Radiator coolant		-	(Replace once a year: R)						
(※2: High-quality glycol-based antifreeze)		-	(Replace every two years: R)						

※1PT: Permanent type

※2 Good quality ethylene glycol antifreeze

POWERSTAR



Maintenance schedule (No.3)

I: Inspect, clean up and repair as necessary A: Adjust R: Replace T: Tighten to specified torque L: Lubricate
Use odometer reading or period, whichever comes first.

Service interval	×1,000 km Or monthly	Initial I	Every driving				
				8	12	24	48
			4 1	2	3	6	12
Turbocharger			I	-	-	-	-
Air supply pipe fittings and gaskets		-	I	-	-	-	R
Air tightness gasket and O-ring			I	-	-	-	-
Clutch			I	-	-	-	-
Clutch fluid		-	I	-	-	-	R
Performance of clutch system		-	I	-	-	-	-
Clutch pedal free stroke and pedal stroke		-	I	-	-	-	-
Clutch air booster vent cap		-	-	-	-	-	-
Transmission							
* Transmission gear		R	I	-	-	-	R
Loosen of gear control mechanism		-					I
Transmission shaft							
Is the connection loosened?		-	-	-	-	I	-

POWER STAR



Maintenance schedule (No.4)

I: Inspect, clean up and repair or replace as necessary A: Adjust R: Replace T: Tighten to specified torque L: Lubricate
 Use odometer reading or period, whichever comes first.

Service interval	×1,000 km Or monthly	Initial	Every driving				
		1	4 1	8 2	12 3	24 6	48 12
* Wear of joints and splines		-	-	-	-	-	I
Loose bearings and related parts		-	-	-	-	-	I
Rear axle							
Differential gear oil (Isuzu type)		R	I	-	-	-	R
<u>FVZ</u> Middle differential gear oil		R	I	-	-	-	R
Grease for rear wheel bearing		-	-	-	-	-	R
Damage and deformation of the rear axle housing		-	-	-	-	-	I
Front axle							
Front wheel bearing grease		-	-	-	-	-	R
* Grease for front wheel bearing (oil injection type)		R	-I	-	-	-	R
Damage and deformation		-	-	-	-	-	I
Suspensions							
* Leaf spring U-shaped bolt nut		T	-	-	-	-	T

POWER STAR



Maintenance schedule (No.5)

I: Inspect, clean up and repair or replace as necessary A: Adjust R: Replace T: Tighten to specified torque L: Lubricate
Use odometer reading or period, whichever comes first.

Service interval	×1,000 km Or monthly	Initial	Every driving				
		1	4 1	8 2	12 3	24 6	48 12
Spring damage		-	I	-	-	-	-
The leaf spring loses the elasticity		-	-	-	-	-	I
Loosening and damage of the installation site		-	-	-	I	-	-
Axis eccentricity of leaf spring		-	-	-	-	-	I
Prevents leaks and damage of shock absorbers		-	-	-	I	-	-
The shock absorber is leaked or damaged		-	-	-	I	-	-
Wheel							
Foreign objects clamped or not		-	I	-	-	-	-
Tightening of wheel nut		T★	T	-	-	-	-
Damage of wheel disc		-	I	-	-	-	-
The front hub bearings are loosened		-	-	-	-	I	-
The rear hub bearings are loosened		-	-	-	-	I	-

★ Retighten ISO8 wheel hub bolts again as per page 82.

POWER STAR



Maintenance schedule(No.6)

I: Inspect, clean up and repair or replace as necessary A: Adjust R: Replace T: Tighten to specified torque L: Lubricate
 Use odometer reading or period, whichever comes first.

Service interval	×1,000 km Or monthly	Initial	Every driving				
		1	4 1	8 2	12 3	24 6	48 12
Steering system							
Power steering oil		-	-	-	-	-	R
Power steering oil filter		-	-	-	-	-	I
Loosening of the mounting area		-	-	-	-	-	-
Excessive free stroke of bearing		-	-	-	-	-	I
* Damage, looseness and excessive gap of the steering linkage		I	-	-	I	-	-
Clearance between knuckle and front axle		-	-	-	-	-	I
Wheel adjustment		-	-	-	-	-	I
Left and right turning circle		-	-	-	-	-	I
Gap between the steering knuckle kingpin and the bearing		-	-	-	-	-	I
Service brake							
*Wear of the friction plate		-	-	-	I	-	-
* Wear and damage of brake drum		-	I	-	-	-	R



Maintenance schedule (No.7)

I: Inspect, clean up and repair or replace as necessary A: Adjust R: Replace T: Tighten to specified torque L: Lubricate
 Use odometer reading or period, whichever comes first.

Service interval	×1,000 km Or monthly	Initial	Every driving	8	12	24	48
		1	4	2	3	6	12
Brake hose		-	-	-	-	-	I
Bleeding, damage and loose fittings of brake pipes and hoses		-	I	-	-	-	-
The cam and the wheel brake are worn excessively		-	-	-	-	-	I
Stroke of braking chamber, piston rod		-	I	-	-	-	-
Function of the brake chamber		-	-	-	-	-	I
Function of brake valve and relay valve		-	-	-	-	-	I
Parking brake							
Wear of the friction plate		-	-	-	-	-	I
The brake drum is worn or damaged		-	-	-	-	-	I
Loosen of support plate		-	-	-	I	-	-
Damage and looseness of connecting rods and cables		-	I	-	-	-	-
Function of control valve		-	I	-	-	-	-
Spring chamber function		-	-	-	-	-	I

POWER STAR



Maintenance schedule (No.8)

I: Inspect, clean up and repair or replace as necessary A: Adjust R: Replace T: Tighten to specified torque L: Lubricate
Use odometer reading or period, whichever comes first.

Service interval	×1,000 km Or monthly	Initial	Every driving				
		1	4 1	8 2	12 3	24 6	48 12
Brake spring chamber piston rod stroke		-	-	-	-	-	-
Electrical equipment		-	-	-	I	-	-
Specific gravity of electrolyte		-	-	-	I	-	-
Activated function		-	-	-	-	-	I
Starter brush wear		-	-	-	-	-	-
Generator function		-	I	-	-	-	-
Damage and relaxation of wire harness post		-	I	-	-	-	-

Please refer to pages 132 and 133 of this book for the location of the lubricant filling point.

POWERSTAR



Lubrication schedule

L: Lubricate

Use odometer reading or period, whichever comes first.

Service interval	×1,000 km Or monthly	Initial	Every driving				
		1	4 1	8 2	12 3	24 6	48 12
Grease filling point							
Engine water pump bearing		-	L	-	-	-	-
Front spring pin		-	L	-	-	-	-
Front hook pin		-	L	-	-	-	-
Kingpin hole of steering knuckle		-	L	-	-	-	-
Steering drag rod (except maintenance-free)		-	L	-	-	-	-
Steering clutch release bearing sleeve		-	L	-	-	-	-
Rotating axis steering knuckle universal point and sliding sleeve		-	L	-	-	-	-
Vehicle drive shaft center bearing		-	L	-	-	-	-
Rear spring pin		-	L	-	-	-	-
Rear eye pin or rear slide plate		-	L	-	-	-	-
<u>FVM FVZ</u> Trunnion		-	L	-	-	-	-
<u>FVMFVZ</u> Rear spring sliding pad		-	L	-	-	-	-
Front wheel brake camshaft and clearance adjustment mechanism		-	L	-	-	-	-



Lubrication schedule

L: Lubricate

Use odometer reading or period, whichever comes first.

Service interval	×1,000 km Or monthly	Initial	Every driving				
		1	4 1	8 2	12 3	24 6	48 12
Rear wheel brake camshaft and gap adjustment mechanism		-	L	-	-	-	-
Steering wheel universal point and sliding sleeve		-	L	-	-	-	-

Refer to pages 134, 135 of this book for the locations of the grease filling points.



POWERSTAR

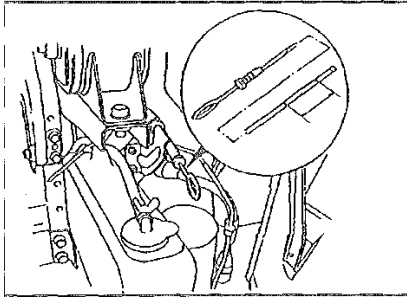

MAINTENANCE GUIDE REGULAR INSPECTION

Oil level

Pull out the oil dipstick (oil level gauge), clean it and insert it in place.

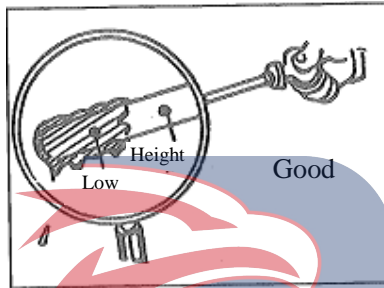

Pull out the oil gauge again to check if the oil level is between the two oil level marks. Also check the oil contamination on the oil gauge.

When checking the level of engine oil, the vehicle should be parked on a flat surface (Before the engine runs).

If the engine is operated, must maintain the engine stop for 5 min to stabilize the oil level before the oil level check.

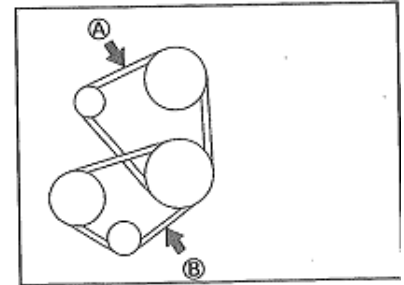

Fan belt

Press down the middle of the belt with a force of 10 kg and check that the deflection of the fan belt is approximately A: 13, B: 10 mm. At the same time, check the belt for cracks and damage.

When it is necessary to replace it, replace the two belts at the same time.

POWERSTAR

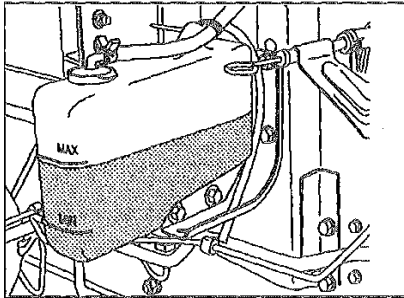

Coolant level

Check the coolant level and refill the coolant in the reserve radiator tank as required. When the water level in the auxiliary tank is below the "MIN" marking, check the radiator and other cooling system parts for leaks and fill water to the "MAX" marking.

1. Do not fill the coolant over "MAX" mark.
2. The radiator filler cap cannot be removed unless necessary.
3. The level of coolant should be checked when the engine cools down.

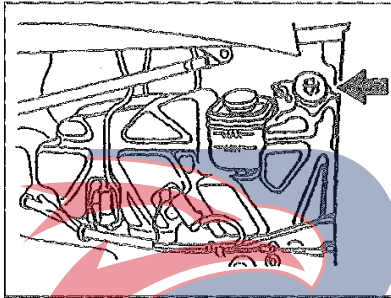

Level of window washer

Check that the tank is full of washing liquid.

1. The use of detergents or other solutions can lead to clogging of piping, so it is very important to use window washing solutions.
2. Do not use radiator antifreeze in the windshield washer.

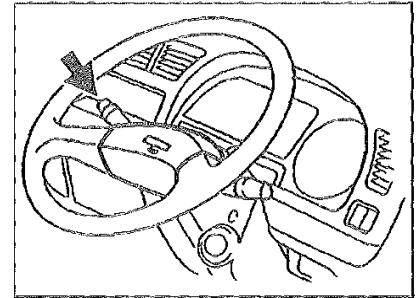

Pull up the switch lever and check that the washing solution is just spraying onto the windshield.

Washing equipment should not be used when there is no solution in the tank.

POWERSTAR

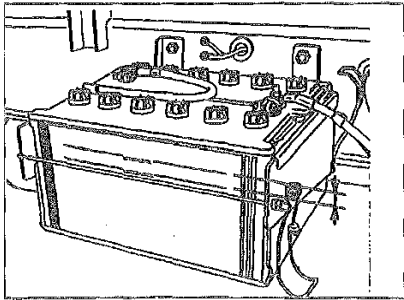

Battery electrolyte level

Check the electrolyte level in each cell and fill with liquid (distilled water) as required to the specified liquid level. The electrolyte cannot be filled excessively beyond the level specified in the specification.

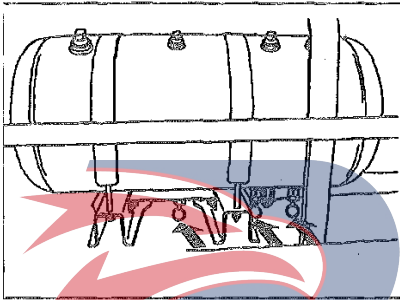

Exhaustion of air box

When the air box exhausts air, let the water out of the air box at the lower part of the switch. After the vehicle is driven, must discharge the water to prevent the water from freezing inside the tank at night.

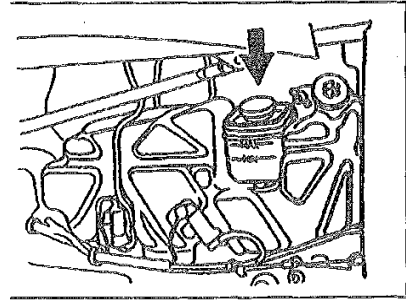

Clutch level

Check that the fluid is at the specified fluid level. If the fluid level is low, use hydraulic brake fluid to refill.

POWERSTAR

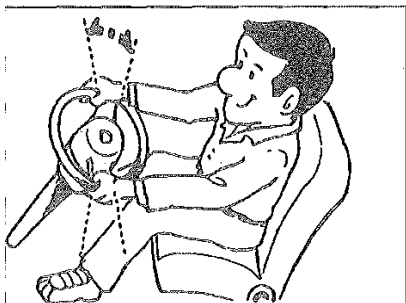

Steering wheel

When the engine is running, turn the steering wheel in the left-right direction until the tire starts moving. Check the amount of free play of the steering wheel.

The standard of free rotation is as follows:

Power steering gap: 10 ~ 60 mm

Check the front wheel to make it in the straight forward position and check in the outer circumference of the steering wheel.

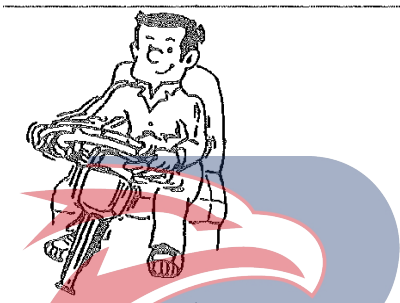

Not only check the free rotation range of the steering wheel, but also determine its swing range in any direction.

When driving under difficult conditions, the swing vibration of steered wheel and the tendency of steering wheel must also be checked when operating the steering wheel.

Check the steering wheel for free rotation while the engine is running.

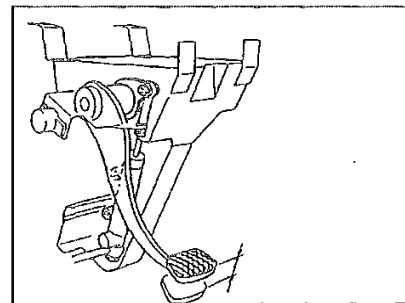

Clutch pedal free play and stroke

Standard value

① Pedal stroke

Types	Model	Pedal stroke
Follower cylinder	MLD	45-65 mm
	MLD	55-75 mm
Air booster	MRB	55-75 mm

② Stroke

180 mm

POWERSTAR

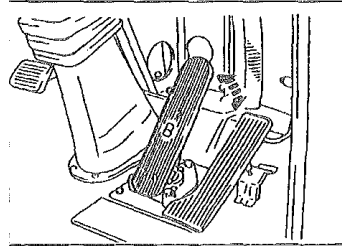

Free play of brake pedal

Standard value: 9-14 mm

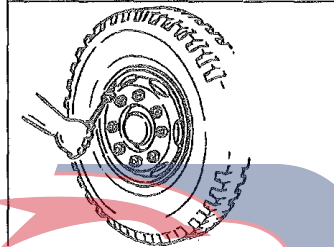

Tire inflation pressure, damage and tread wear

Standard tire inflation pressure

Front and rear wheels and spare tire specifications	Factory pressure (Kpa)	Applicable models
10.00-20-16PR	630 ±20	FVR, CVR
10.00-20-16PR	700 ±20	FVM, FVZ
10.00R20-16FR	670 ±20	FVR, CVR
10.00R20-16PR	740 ±20	FVM, FVZ
U.00-18PR	740 ±20	FV*, GVR, CXA
11.00R20-16PR	770 ±20	FV*, GVR, CXA

In the actual use process, the user must make adjustments according to the actual cargo situation and refer to the following requirements in accordance with national standards.

10.00-20-16PR and 11.00-20-18PR maximum tire inflation pressure: 810KPa

10.00R-20-16PR and 11.00-R20-16PR maximum tire inflation pressure: 840KPa

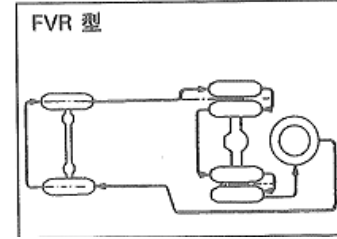

Tire replacement

The tires may subject to uneven wear depending on their mounting positions.

Rear-wheel is worn severely, because both the running and parking brakes have to act alternately on the rear wheels. The braking efficiency of the front wheels has a great influence on the suspension device, steering and front wheel positioning. Check and replace the tire regularly, as shown in the figure.

* When changing tires, try to change the original outward orientation into inward orientation for installation.

* Always use the same type of tire on the same axle. If different types of tires are used on the same axle,

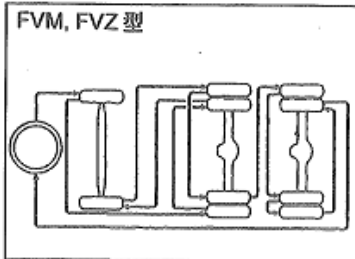

It may cause that the vehicle slips to one side or the steering wheel is not controlled in the correct direction when braking.

* New tires are more prone to heat and worn faster. Therefore, it should be installed to the side of the front wheel with less load.

* If there is an extrinsic difference between the twin tires (parallel twins), install the tire with the smaller outer diameter to the inside.

* The difference of the outer diameter between the two tires should be used within the difference values listed in the table below and these values should not be exceeded.

Outer diameter difference
Twill ply tire
Within 12 mm



Smoke exhaust status

After the engine is warmed up, check the color of exhaust.

Colorless or light blue: Complete combustion (under good conditions)

Black: Incomplete combustion

White smoke: The oil is burned or the engine is not fully heated.

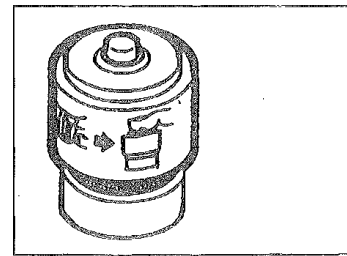

Regular maintenance

Air filter

The use of dirty air filters will not only reduce engine power, but also increase fuel consumption and black smoke. When the filter cartridge is contaminated, the red filter indicator will be turned on. The air filter should be maintained as follows.

When the air filter is blocked, the red indicator for dust lights up.

POWERSTAR

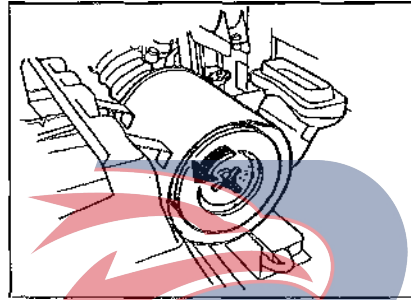

1. Internal inspection and maintenance

When the air filter is cleaned, the red indicator lamp is on. This indicator is located at the rear of the air cleaner housing.

2. Replacement of external filter element

The outer filter element shall be replaced after being cleaned 6 times a year or repeatedly, or when damage is found. (When replacing the filter, the gaskets must be replaced together.)

For 2-stage air filter, the filter cartridge can be replaced but not be removed and cleaned.

When the exposed filter cartridge is replaced or the inner filter cartridge is damaged, the inner filter cartridge must be replaced.

When replacing, it is better to use genuine Isuzu filter, otherwise it will reduce the filtration efficiency, and may damage the engine.

POWERSTAR

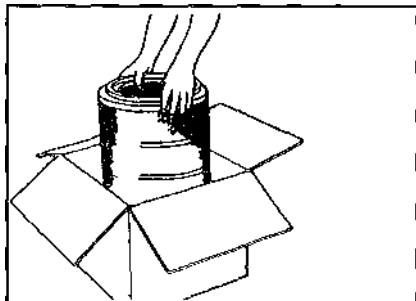

3. General precautions

- * Do not use deformed or damaged filter elements.
- * Do not remove the filter element for cleaning the dusty areas, whether the engine is running or not.
- * When cleaning the filter element, be careful not to get dust or impurities into the air filter body.

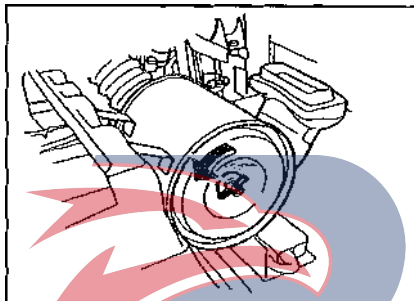

4. Removal of filter element

- 1) Loosen the wing nut and remove the cover.
- 2) Remove the wing nut that secures the filter element (or outer core) and remove the filter element. Handle the filter element carefully so that it is not damaged.

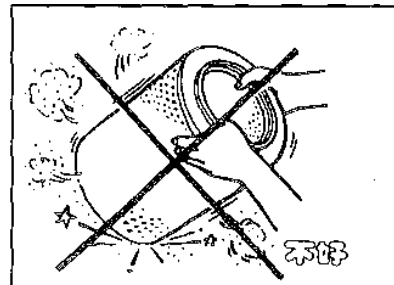

5. Clean

- 1) paper type filter element
The filter element should be cleaned by one of the following two methods according to its contamination. When cleaning dust, prevent collision, otherwise it will deform the filter element and even destroy it.

POWERSTAR

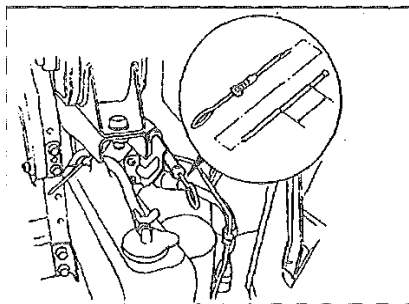

Start the engine and check for oil leaks.
Stop the engine. After a steady state of oil for 5 minutes, check the oil level with a dipstick and refill if necessary.

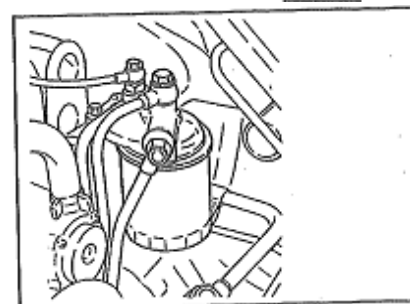
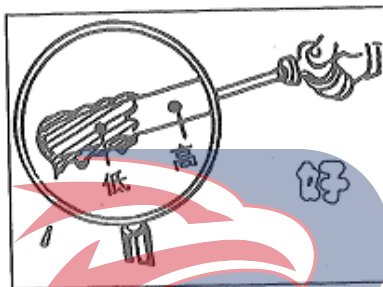

Fuel filter (tube type)

1. Use a filter wrench to remove the fuel filter.
2. Apply a thin layer of engine oil to the surface of the gasket. Screw in a new oil filter by hand until the seal gasket is on the sealing surface. Then, tighten the filter further 2/3 turns by hand.

Exhaust of the fuel system should be performed after the maintenance operation to check for leaks (refer to "exhaust of fuel system").

POWERSTAR

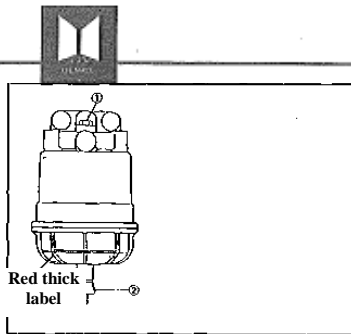

Water Separator (Fuel sedimenter)/Fuel Filter (Combined) in Fuel System

When the red buoy starts to reach the drain level, the water separator should be drained as described below.

1. Place a water container under the water separator drain plug (with capacity of approx. 0.2 L)
2. Loosen the air intake plug and drain plug counterclockwise until the water drains completely.
3. After draining, tighten the drain plug and intake plug. Operate the priming pump on the injection pump to drain the fuel supply system. (refer to "fuel drain and supply system")

- ① Intake plug
- ② Drain plug

4. After starting the engine, check for leakage of fuel from the bleeder plug.

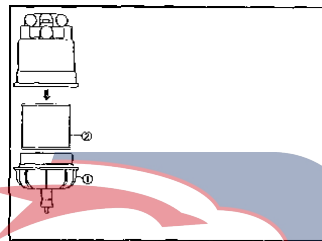

Maintenance of the fuel strainer is performed in the following manner.

If necessary, it should be replaced with original Isuzu brand fuel filter kit.

1. Loosen the transparent cover and remove the filter element together with the cover.
2. Remove the old filter cartridge, insert a new one and tighten securely the lid.

- ① Cover
- ② Filter element

After the maintenance, must exhaust the fuel system and check it for oil leakage.

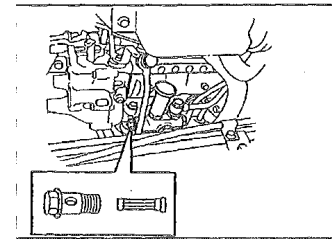

Fuel pump

At the side of the fuel tank on the dispensing pump, remove the tie bolt, unscrew it counterclockwise and clean it. Then use the direct injection pre-injection pump to input fuel.

POWERSTAR

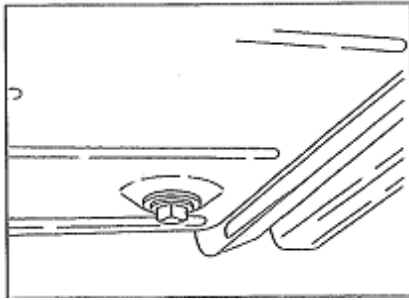

Fuel tank

Remove the drain plug and drain the water and sediment completely.

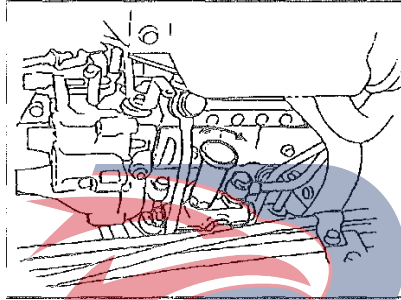

Deflation of oil supply

If the fuel tank is empty, the air can enter the fuel supply system. In order to prevent that the fuel flowing to the engine is blocked. The fuel supply system can be deflated.

1. Loosen the priming pump cover and then use a wrench to loosen the coupling screw.

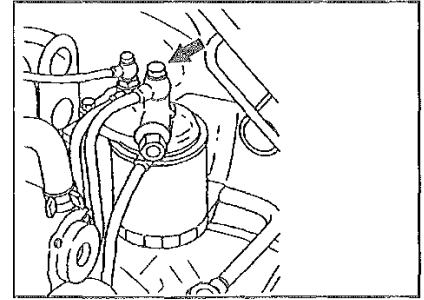

2. Use a wrench to loosen the fuel filter exhauster and allow the fuel pump to pump fuel so that the fuel flows out of the vent plug until bubbles in the fuel disappear.

3. When the bubbles disappear and the fuel flows out, tighten the fitting screws and the start pump cover in normal procedure.

If they cannot be fully tightened, there is a possibility of air mixing into the fuel system.

POWERSTAR

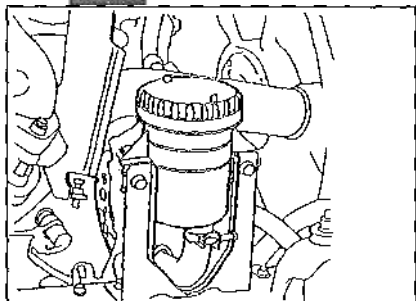

Power steering oil filter

Clean the power steering oil filter in the transmission as follows:

1. Remove the filter cover.
2. Remove the filter and wash the filter in light oil. Use compressed air (2 kg/cm^2) to blow dust off the filter. Be sure to blow the compressed air from the outside.
3. Clean the filter completely in light oil again.
4. The filter shall be blown dry with compressed air and the light oil above shall be blown away.
5. Install the filter and secure the cover.

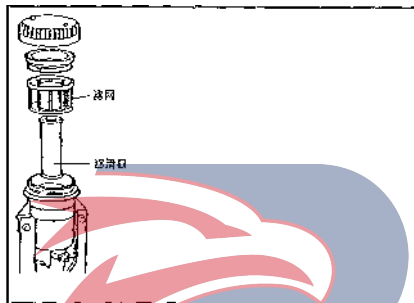

6. Remove the oil filter mesh and check for dust. If necessary, remove the dust and check the oil level. Be careful not to allow sand and other substances to enter the power steering tank. Contaminants in the tank will cause failure of the power steering unit.

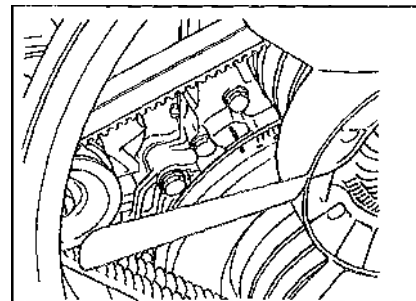

Valve clearance adjustment

1. Turn the crankshaft until the top dead center mark on the crankshaft pulley shock absorber is aligned with the timing mark, to move the piston in 1st or 6th cylinder to the top dead center of the compression stroke.

POWERSTAR

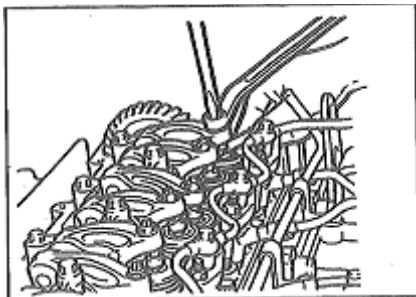

2. Use the gauge to adjust the valve clearance as follows:
Air valve gap (when engine is cold)
Exhaust: 0.4mm
Exhaust: 0.4mm

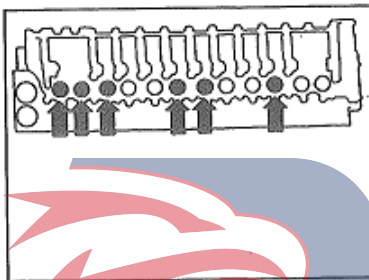

3. First adjust the valve gap shown by the arrow in the figure.

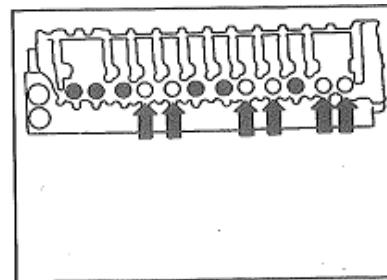

4. Rotate the crankshaft one revolution (360 degrees) and continue to adjust the valve clearance indicated by the arrow in the figure.

POWERSTAR

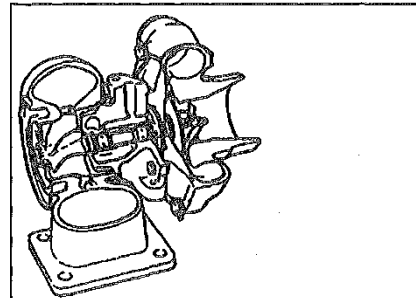
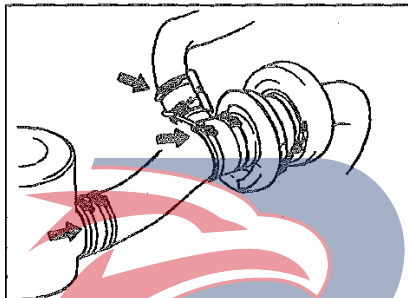

Turbocharger

The proper routine maintenance and regular overhaul methods for turbocharged diesel engines are described in the section. To keep your vehicle in the optimal conditions, it is recommended to read the section carefully.

1. Check all air line fittings and gaskets regularly for leaks and repair loose or leaky fittings immediately.

If the air to be compressed contains dust, wear and damage to the components of the turbocharger and the engine will occur. Leaky pressure fittings will lead to power loss and engine overheating.

2. Replace all gaskets and O-rings regularly.

POWERSTAR

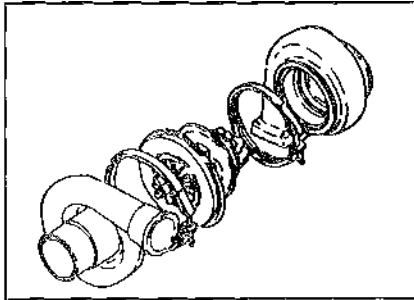

3. Even if no special problems were found through regular inspections, overhaul of turbocharger must be performed every 200,000 kilometers.

4. The following items should be checked. If any of them is found to be problematic, take necessary repair measures.

- * Abnormal noise
- * Decrease in engine output power
- * Exhaust black smoke
- * Increased fuel consumption
- * Oil leakage around the turbocharger
- * Excessive air leakage from the vent

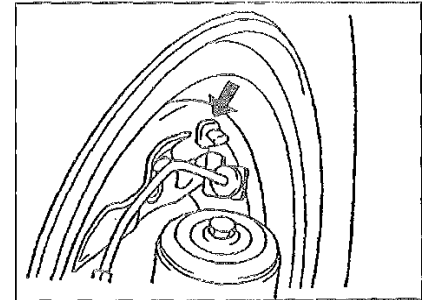

Inspection of brake lining

1. Visually inspect the brake lining edge for wear through inspection hole in the brake shoe.
2. If the edge of brake lining is found to be worn, the brake lining must be replaced with a new one.

POWERSTAR

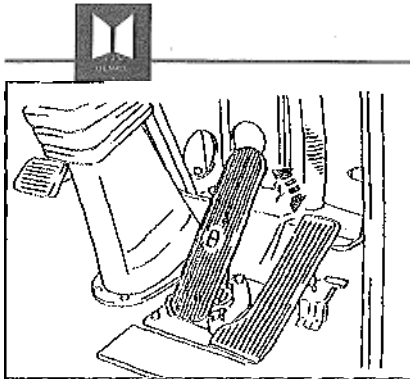

Adjust clearance of brake lining

If the brake system is used, if there is a large gap between the brake linings and thus the brake cannot be applied safely, check and adjust the clearance of brake linings.

Before starting to adjust the clearance of the brake lining, all the wheels should be fixed in advance with pads to prevent the vehicle from sliding.

Then use the jacks to lift the wheels to get the wheels off the ground and padded into the appropriate stand to support the wheels.

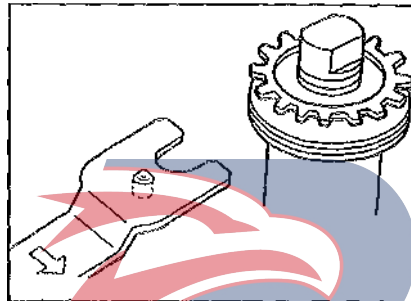

OPT Brake (rear wheel parking brake) adjustment

Remove the rubber plug from the adjustment holes above and below the rear wheel brake cylinder and adjust the brake with the brake adjustment tool (provided as an accessory for the vehicle).

- Insert the adjustment tool into the adjustment hole and fix it on the adjustment bolt, and then tighten the adjustment tool in the direction of the arrow marked on the adjustment bolt to make the brake shoe expanded.

- When the brake shoe is jammed due to contact with the brake drum, and the wheel or brake drum is in a state where it cannot be further twisted, the adjustment tool should be twisted reverse direction by 6 teeth.

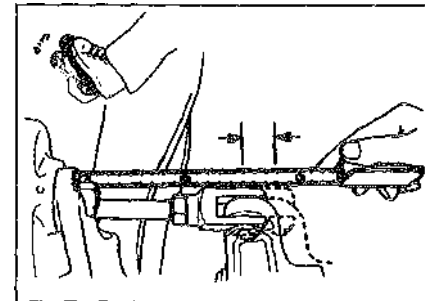

All pneumatic brakes (ISUZU type) are adjusted as follows:

When releasing the depressed brake pedal, the stroke of the push rod is measured with a ruler parallel to the brake lever.

mm

	Standard trip value	Use limit
Front wheel brake	25-30	40
Rear brake, Rear axle front shaft brake	25-30	45
Rear axle rear shaft brake	28-33	45

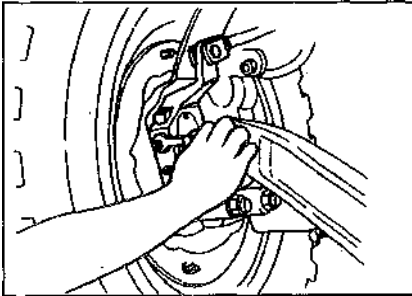

If the actual push rod stroke of the brake is close to or exceeds the apply limit, must adjust it with the following method.
Turn the worm on the gap adjuster clockwise to adjust the brake puller stroke.

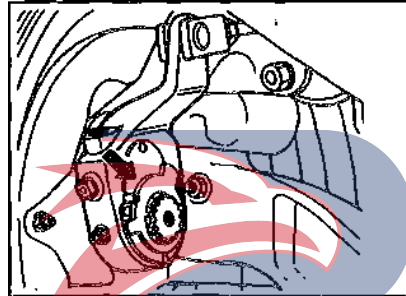

When the brake level stroke is within the standard value range, the brake friction lining gap will be adjusted to about 0.3 mm. When the worm is used to adjust the stroke of the push rod, if the protruding part of the indicator touches the stopper, it means that the brake lining has worn out to the limit value and needs to be replaced immediately.

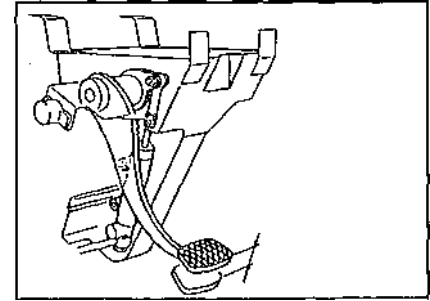

Clutch pedal adjustment

The free play of the clutch pedal ensures that the clutch has a sufficient friction.
The clutch pedal free stroke is adjusted as follows. If you do not make adjustments, it will cause the clutch to slip and stop driving.

POWERSTAR

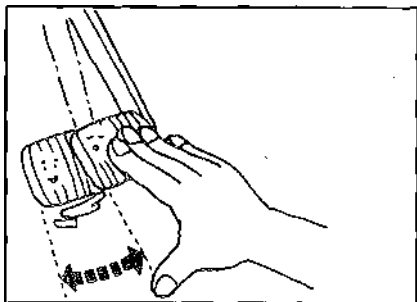

Free play checking:

Depress the clutch pedal carefully until a strong resistance is felt, and check the free stroke before a strong resistance is felt.

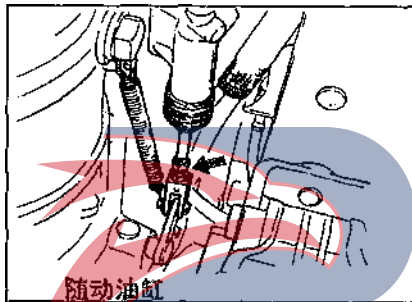

Adjust the free play:

1. Remove the return spring on the hydraulic follower cylinder.
2. Unscrew the push rod lock nut on the hydraulic transfer pump and slowly turn the push rod in the direction of its elongation until you feel resistance, then screw the push rod back to the turns listed in the table below.

Types	Model	Number of revolutions
Follower cylinder	MLD	2-3/4
Air booster	MLD	4 - 1/2
	MRB	4-1/2

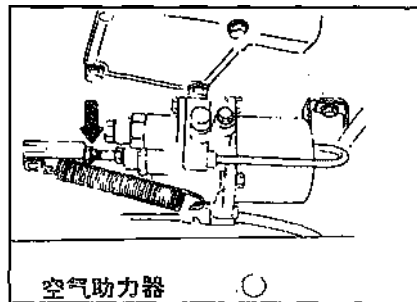

3. Tighten the nut and install the return spring. Then set the free play of the clutch pedal to the given value range listed in the table below.

Types	Model	Pedal stroke
Follower cylinder	MLD	45 - 65 _mm
Air booster	MLD	55-75 mm
	MRB	55-75 mm

After the adjustment work is finished, be sure to check whether the free play of the clutch pedal meets the standard.

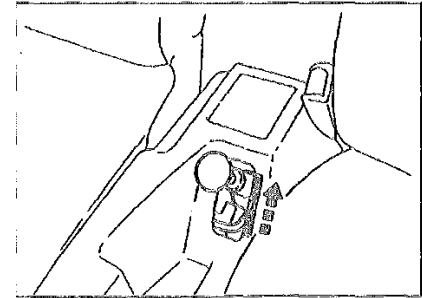
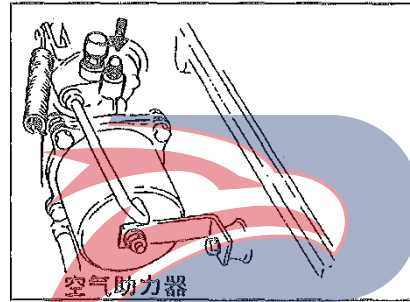

Clutch hydraulic system deflation

If air enters into the clutch piping, it will cause drag of the clutch. Therefore, if the clutch is used with insufficient fluid in the clutch tank, or if the hydraulic system is disassembled during clutch repair, venting must be performed. The ventilation should be performed by two persons.

Follow the instructions below to deflate

1. Apply the parking brake or spring brake

POWERSTAR

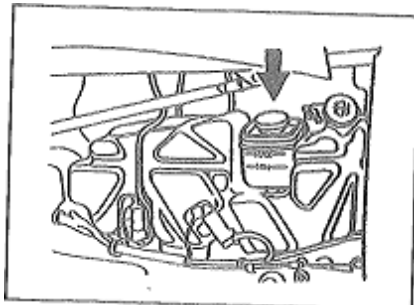

2. Check the clutch fluid level in the clutch groove and refill as necessary.

Brake fluid dissolves paint and plastic, vinyl, rubber, etc, and has a strong performance of corroding metal, so when it overflows, it should be immediately wiped or fully washed.

Due to the strong hygroscopicity of the brake fluid, be careful not to mix in moisture during the initial filling and during maintenance.

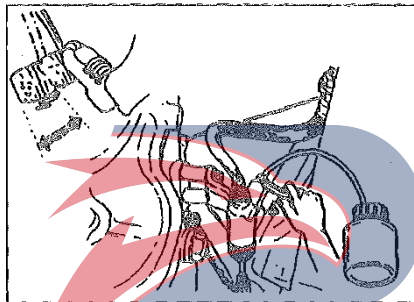

3. Remove the rubber cap from the bleeder screw, clean the bleeder screw, connect the vinyl tube to the bleeder screw, and place the other end of the vinyl tube into the transparent container.

4. Depress the clutch pedal repeatedly and then depress and hold it.



5. Loosen the bleeder screw on the clutch booster, place the clutch fluid with air bubbles into the container, and immediately tighten the bleeder screw.

6. Release the clutch pedal carefully. The above operation is repeated until there is no bubble in the clutch fluid pumped into the container. During ventilation, keep the clutch fluid in the clutch tank at the specified fluid level. Reinstall the rubber cover.

POWERSTAR

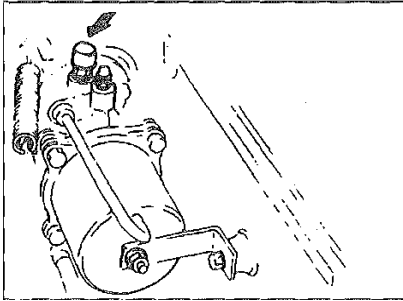

Drain hole cover of air booster

The drain hole cover of air booster should be disassembled and cleaned periodically.

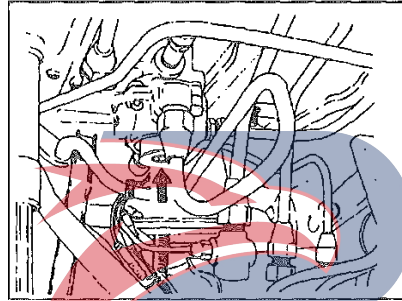

In-valve drain hole rubber cover

The drain hole rubber cover shall be cleaned.
Double-linkage control valve:

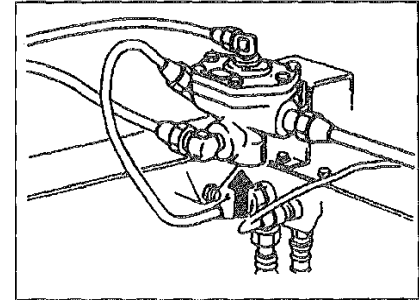

Relay valve:

POWERSTAR

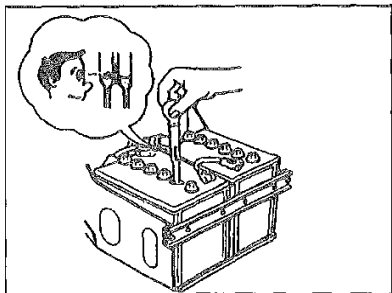

Battery electrolyte specific gravity

At 20°C, if the reading of specific gravity of electrolyte on the hydrometer is 1.26, the battery is fully charged. If the specific gravity is lower than 1.23, the battery needs to be recharged.

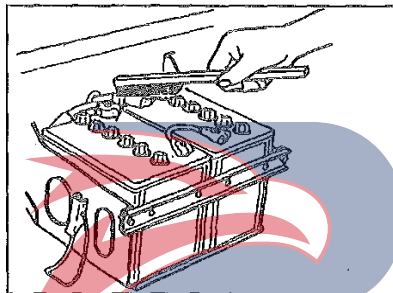

Clean the battery

If the external parts of the battery are dirty, it can be cleaned with slightly warm water. The battery terminals should be coated thinly with petroleum jelly or grease to prevent corrosion.

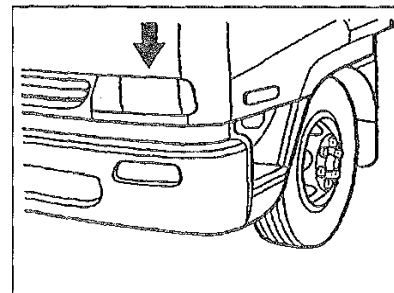

Headlights

Properly align the headlights to ensure adequate lighting on the road without causing glare to other drivers, which is the most important work. If necessary, the headlights should be adjusted optionally on a QingLing Motors dealer with special devices.

POWERSTAR



Replacing light bulbs

When replacing the light, make sure that the light switch is set to the “OFF” (switch off) position. The bulb should be replaced with a new one with same capacity.

Standard ratings of lamp wattage are listed below.

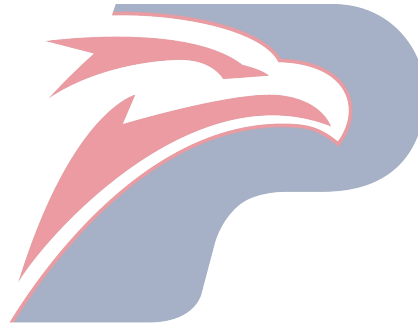

POWERSTAR



Bulb

Light name		Power (W)	Number of bulbs	
Headlight assembly	Rectangle light	Outside	75/70W	2
		Inside	70W	2
Front combination lamp	Side Marker Lamp	5W	2	
	Turn signal	21W	2	
Side turn signal		21W	2	
Rear combination lamp	Parking light / tail light	21/5W	2	
	Turn signal	21W	2	
	Reversing lights	21W	2	
License plate light		10W	1	
Indoor lights		10W	1	
Recognition light		5W	2	
Front fog lights		70W	2	

POWERSTAR

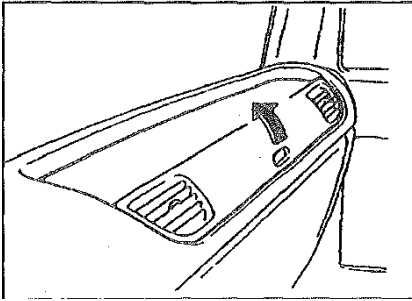

Fused box

A fuse box is installed near the front panel (at co-driver seat), and the box cover can be easily removed manually.

If the fuse blows, to find out the cause of the failure, perform the necessary maintenance and inspection before replacing with a new fuse. If necessary, the fuse should be replaced with a new one with the same capacity.

No.	Current reading	Circuits
1	7.5A	Headlight high beam/Left
2	7.5A	Headlight high beam/right
3	7.5A	Headlight high beam/Left
4	7.5A	Headlight high beam/right
5	7.5A	Clock and dome light spared
6	7.5A	Engine breaker device
7	7.5A	Door lock
8	7.5A	Radio and stereo device
9	7.5A	Glow plug (relay)
11	7.5A	Instrument cluster
12	7.5A	Reversing light, starter auxiliary switch, speaker
13	7.5A	Power take-off device, exhaust throttling auxiliary brake
20	7.5A	Engine electronic control device

No.	Current reading	Circuits
26	15A	Taillights, fog lamps, illumination devices
27	15A	Parking light
28	15A	Starter (relay)
29	15A	(Power output) power outlet
30	15A	Turn signal
31	15A	Fog lights
32	15A	Electric window(Right)
33	15A	Electric window(Left)
36	15A	Blower motor
37	15A	Cold air fan motor, compressor
38	15A	Windshield wipers and washer
40	15A	Cigarette lighter
45	15A	Starter electronic control device

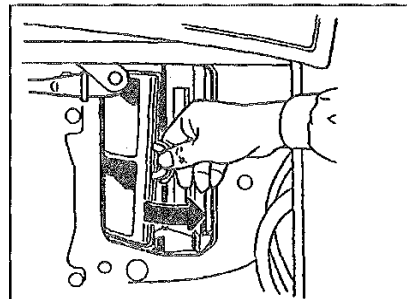
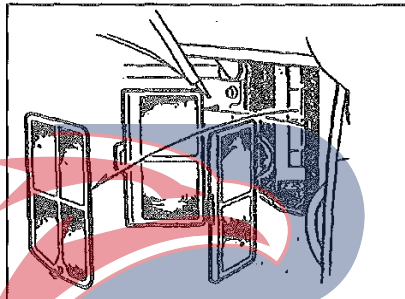
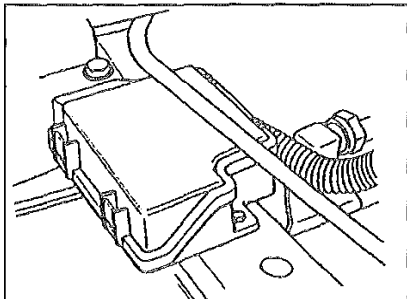

Slow-blowing fuse

If the headlights or other electrical components do not work and the fuses are normal, check the slow break fusible link.

If the slow break fusible link has blown, it should be replaced. If need, Isuzu Pure brand slow-blown fuse should be used.

Even if it is a temporary measure, it is not allowed to install wires such as copper wires. It will cause more damage and may cause a fire.

If the circuit from the battery is overloaded, the slow break fusible link will be blown before all the electrical wiring is damaged.

Before replacing the slow break fusible link, be sure to check the cause of the electrical overload.

OPT Air conditioner filter

1. Open the cab front cover.
2. Remove the air conditioner filter.
3. Blow off the dust with compressed air, or rinse with water (after washing with water, allow the filter to dry).

POWERSTAR

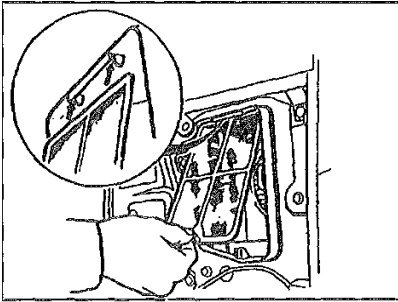

4. Reinstall the filter.

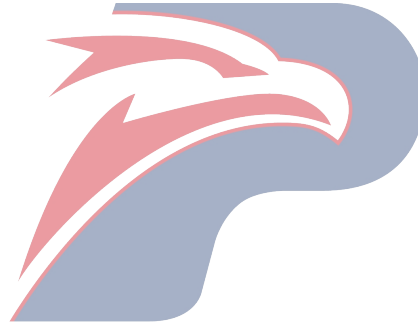

POWERSTAR



Recommended liquids, lubricants, and diesel fuels

In order to achieve the highest performance and longest working life of your QingLing Vehicles, the best lubricants and diesel fuels must be properly selected and used.

When adding the lubricants, be sure to select the original QingLing lubricant or the lubricants recommended in the table below based on the maintenance schedule for each model.

The intervals for adding lubricants as defined in the warranty period and scope of the new vehicle and in the maintenance plan are based on the use of QingLing's original lubricants or the appropriate lubricant brands recommended in the table.

Lubrication range	Vendor	Brand/Model	Grade	
			API	ACEA
Diesel engine crankcase	ISUW GENUINE	BESCO MULTI - ZTYPE CE (LOW - 30)	CE	
	ISUW GENUINE	BESCO MULTI - Z (10W - 30)	CD	
	ISUW GENUINE	BESCO S- 3 (10W, 20W, 30, 40)	CD	
	EXXON/ESSO EXXON/ESSO	ESSOLUBE XD-3 + (15W -40)	CG-4/CF CG-4/CF	E2/B2
	MOBIL	ESSOLUBE XT331 (15W - 40)	CF/CE	E2/B2
	CALTEX/CHEVRON	DELVAC HP (15W-40)	CF	
	SHELL	DELO CXJ (15W - 40, 30, 40)	CD/CF	
	ELF	RIMURA D (15W - 40, 30, 40)	CE	
	TOTAL	PERFORMANCE TROPHY (15W - 40)	CF-4	E3
	CASTROL	RUBIA XT (15W - 40)	ICG-4/CH-4	E2
		RX SUPER PLUS (15W - 40)		

POWERSTAR



Lubrication range	Vendor	Brand/Model	Grade	
			API	ACEA
Manual power train (except FULLER and EZF) Transfer case Differential Grease-lubricated bearings	ISUZU GENUINE EXXON/ESSO MOBIL CALTEX SHELL ELF TOTAL CASTROL CASTROL	BESCO GEAR OIL SH (80W-, 90, 140) GEAR OIL GX (85W - 90) MOBILUBE HD (80W - 90, 85W -140) 1HURBAN CL- 5 EP (80W - 90, 85W - 140) SPIRAX HD (90, 140) TRANSELF TYPE B (80W - 90 ,85W - 140) TRANSMISSION TM (80W - 90, 85W - 140) EPX 90 (90) DYNADRIVE (80W - 90)	GL-5 GL-5 GL-5 GL-5 GL-5 GL-5 GL-5 GL-5	
Automatic transmission Power steering	ISUZU GENUINE EXXON/ESSO MOBIL CALTEX SHELL ELF TOITAL CASTROL CASTROL	ESSCO AFT II, AFT II ESSCO ATF D (DEXRON ^R II-D) MOBIL ATF (DEXRON ^R III) ATF HD (DEXRON ^R II) SHELL DONAX TA (DEXRON ^R II- D) ELFMATIC G3 (DEXRON ^R III) TOTAL FLUND II D (DEXRON ^R II - D) TQ -D (DEXRON ^R II) TQ DECRO III (DEXRON ^R III)		
Center bearing Clutch shift group Lubricate the hubs with grease Propeller shaft fork Knuckle (Multi-purpose grease)	ISUZUGENUINE EXXON/ESSO MOBIL CALTEX/TEXACO SHELL TOTAL CASTROL	BESCO L-2 GREASE (No. 2, L-3 GREASE (No.3) RONEX MP (No.2) MOBIL GREASE HP 222 (No.2) STARPLEX-2 (No.2) RETINAX A (No.2) MULTIS EP2,EP3 (No.2, No.3) LM GREASE (No.2, No. 3)		



Lubrication range	Vendor	Brand/Model	Grade
Engine cooling system	ISUZU GENUINE TEXACO/CALTEX	BESCO LLC SUPER TYPE E HAVOIJNE EXTENDED LIFE ANITIFREEZE COOLANT HAVOLINE XLC EXTENDED LIFE COOLANT6280	

Liquid portion	Model
Electric hydraulic tank tilting pump	MIL- H - 5606E aviation oil equivalent
Clutch and brake fluid tank	Besco brake fluid (For heavy duty) Hydraulic brake fluid SAE J1703 FMVSS 116 DOT.3 grade

Note: Refer to their service manual for FULLER power train and ZF power train.
If the recommended lubricant is specified in the relevant manual, follow the regulations.

Diesel fuel/trial standard
JIS (RIBEN Industry Standard) According to K2204 GAS OIL DIN (German Industry Standard) According to EN 590:1997 SAE (Association of Automotive Engineers Standards) According to SAE J-313C BS (British Standard) According to BS EB590:1997

Note: Trial standards or equivalent specifications for fuel usage.

POWER STAR



Lubricating oil

According to the lubricating oil chart, care should be taken to select the lubricating oil. It is important to select the viscosity of the lubricating oil based on the ambient temperature.

See the chart below.

Engine oil viscosity map

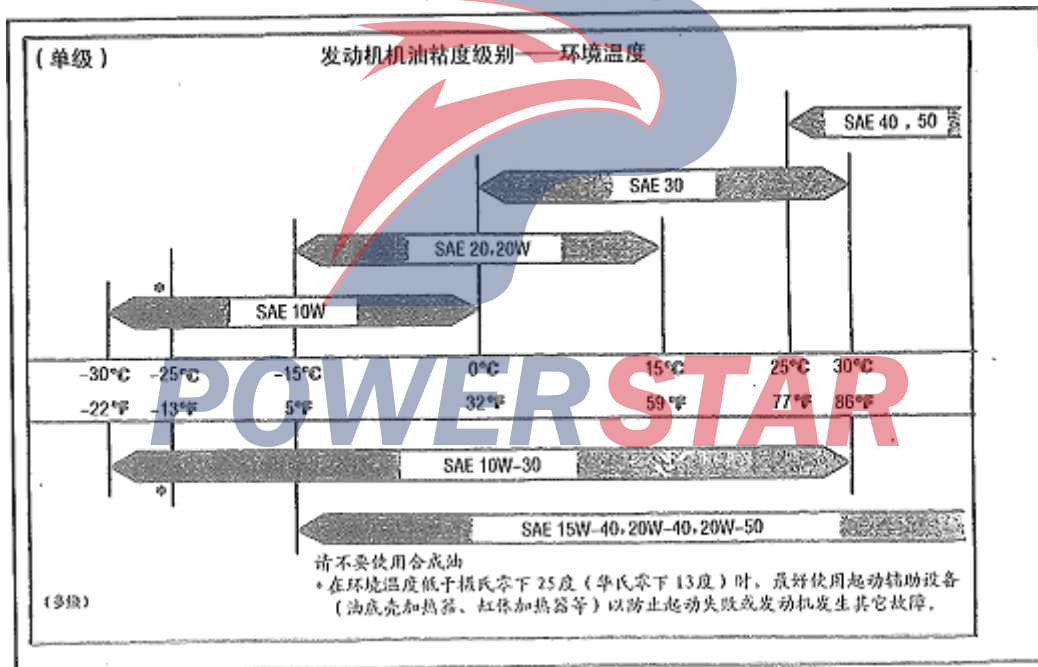



Gear oil viscosity map

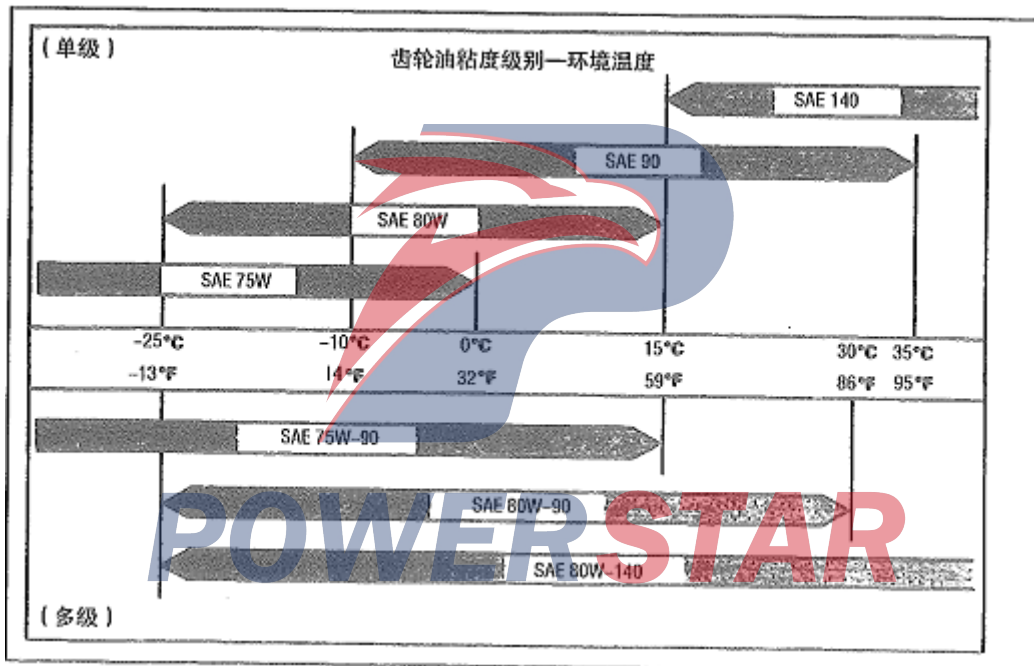



Lubrication table (FVR models)

○ Check or add (E) ... Engine oil (B) ... Brake fluid (E) Replace (G) ... Gear oil (A) ... Automatic transmission fluid (M/W) ... Multipurpose grease (M/W) ... Multipurpose grease or hub bearing grease

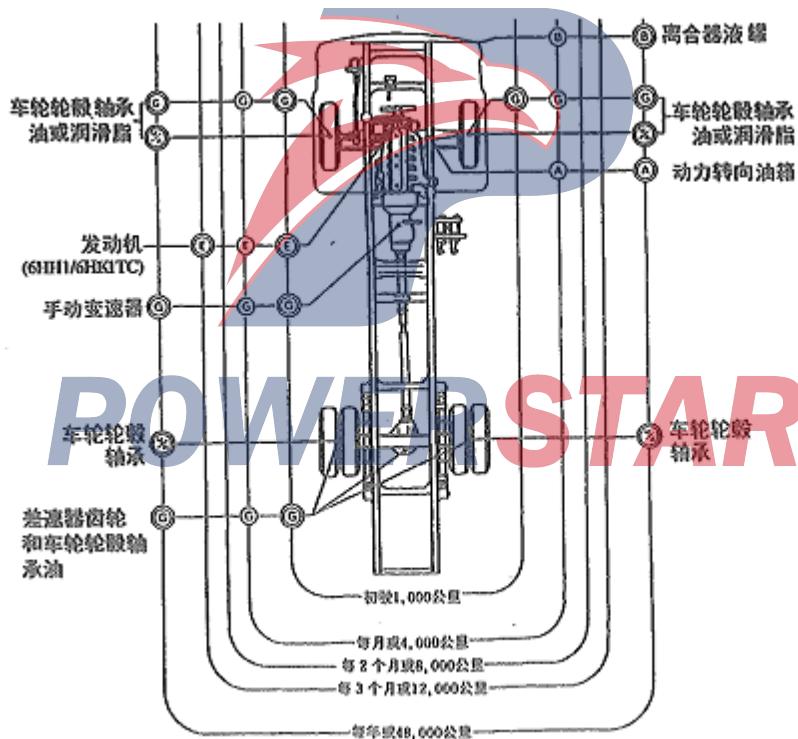



Lubrication table (FVM/FVZ models)

○ Check or add (E) ... Engine oil (B) ... Brake fluid (E) Replace (G) ... Gear oil (A) ... Automatic transmission fluid (M) ... Multipurpose grease (C) Cab tilting pump oil

(M/W) ... Multipurpose grease or hub bearing grease

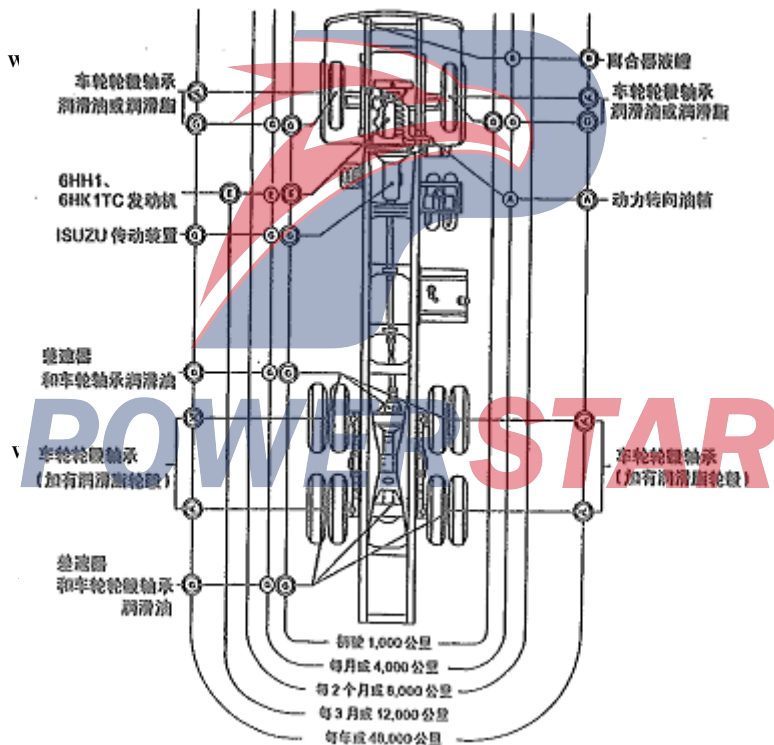



Parts for grease filling (FVR models)

Monthly or every 4,000 km

- ① Steering wheel universal point and sliding sleeve
- ② Straight pole (excluding maintenance-free type)
- ③ Front spring pin
- ④ Steering wheel kingpin
- ⑤ Rotating shaft
- ⑥ Front eye pin
- ⑦ Automobile transmission shaft universal point
- ⑧ Automobile transmission shaft spline shaft
- ⑨ Rear spring pin
- ⑩ Water pump
- ⑪ Clutch shifter
- ⑫ Rear pin
- ⑬ Brakes camshaft

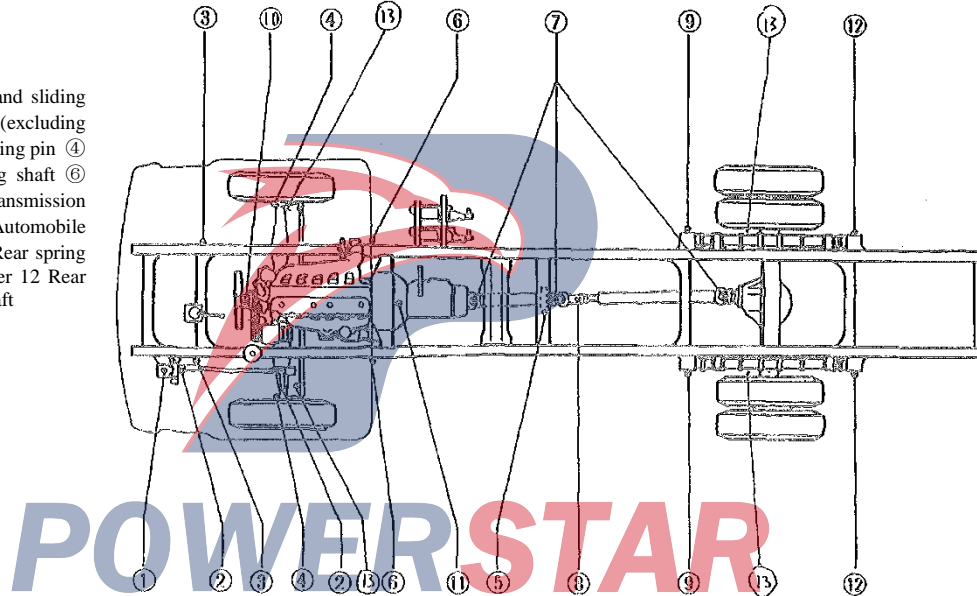



Every 4000 kilometers or once a month

- ① Steering wheel joints and sliding sleeves
- ② Straight pole (excluding maintenance-free type)
- ③ Front spring pin
- ④ Steering knuckle king pin
- ⑤ Clutch shifting device
- ⑥ Eye pin for front spring pin
- ⑦ Drive shaft universal joint, Sliding sleeve, and intermediate bearing
- ⑧ Trunnion
- ⑨ Rear spring slide pad
- 10 Water pump
- 11 Brake camshaft

Parts for grease filling (FVM/FVZ models)

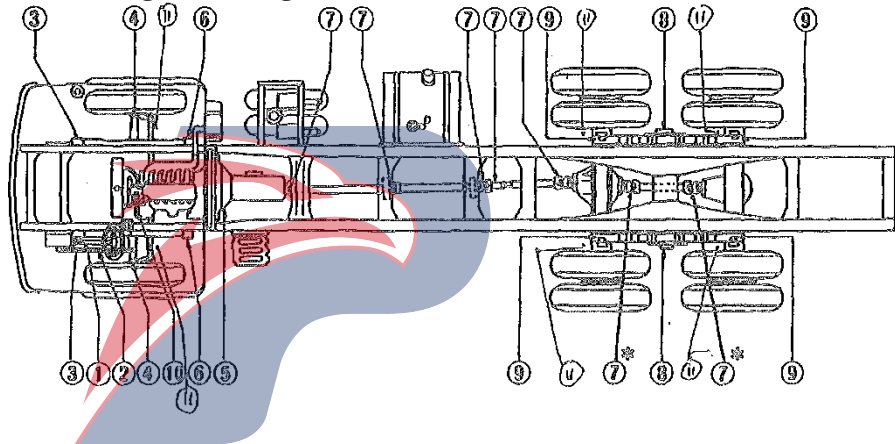

POWERSTAR

* Only for FVZ models

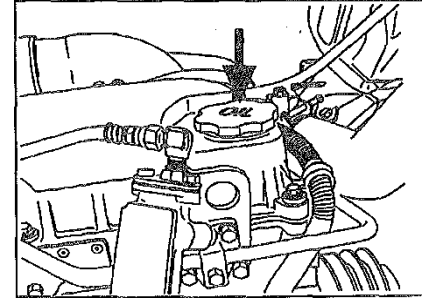
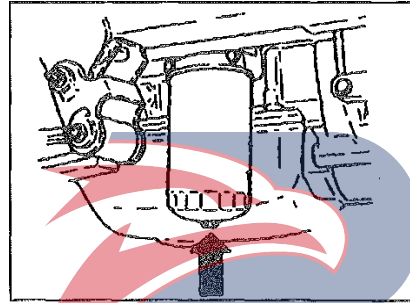
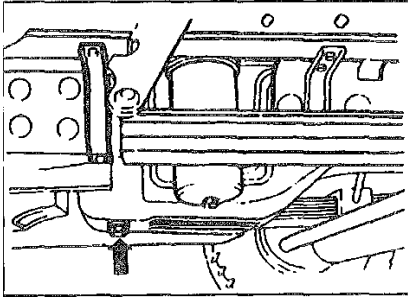

Lubrication guide

Engine oil replacement

Unscrew the drain plug in the lower part of the oil pan to drain the engine crankcase oil.

The warmed oil may cause skin burns. Therefore, be sure to cool the engine before draining the oil.

Drain the oil in the engine crankcase, main oil filter, and branch oil filter completely, and then tighten the drain plug.

Remove the oil level gauge (dipstick). Slowly inject new engine oil of the designated level into the crankcase of the engine and wait 5 minutes before starting the engine. Start the engine and let it idle for 3 minutes, then stop the engine and wait 10 minutes. Pull out the dipstick and check the oil level. The oil level should be between "MIN" and "MAX" marks of the oil level gauge (dipstick). If the oil level is lower than "MIN" mark, the crankcase should be filled with the oil.

POWERSTAR

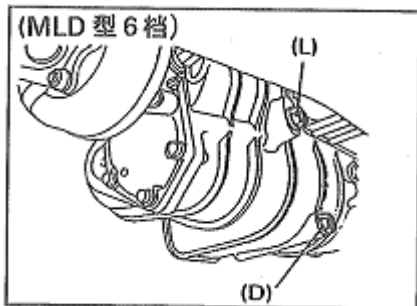

Transmission oil replacement

Disassemble the drain plug (D) under the transmission case and drain oil in the transmission case.

From the oil level inspection plug hole, add the specified gear oil into the transmission to the oil level inspection plug (L) position.

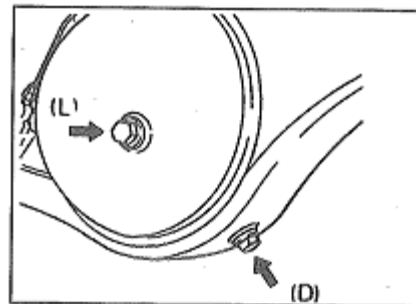
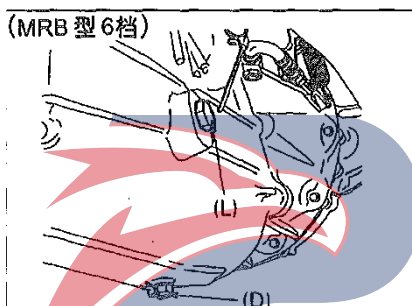

Replacement of main oil (rear axle)

When removing the drain plug (D) below the rear axle housing, drain the gear oil inside the rear axle housing. Then, from the oil level inspection screw plug to the rear axle housing, the specified gear oil is filled into the rear axle housing until the oil level inspection plug (L).

POWERSTAR

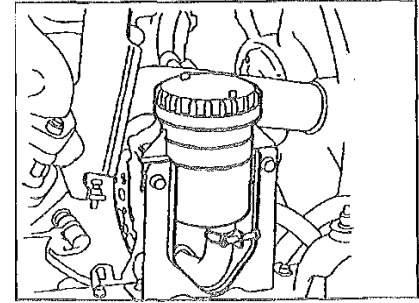
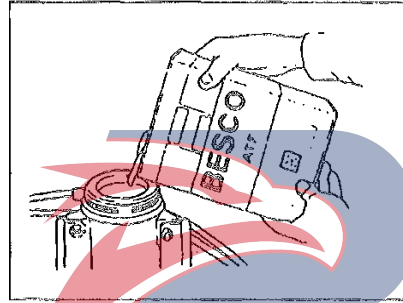
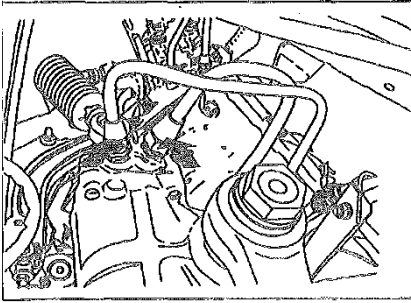

Replacement of power steering gear

Discharge of oil:

1. Use the jack to lift the front wheel off the ground.
2. Loosen the two connecting nuts under the steering device and slowly move the steering wheel in both left and right directions to discharge the oil in the steering device.

Refuel:

1. Tighten the connecting bolt
2. After the tank is filled to the specified level mark, please wait 2-3 min until the level is maintained.

When refilling, refill the tank as needed, and prevent air from entering the hydraulic system

3. Place the front wheels onto the ground, start the engine and operate it at idling speed several minutes, recheck the liquid level and add the standard automatic transmission oil into the liquid tank if necessary.

POWERSTAR

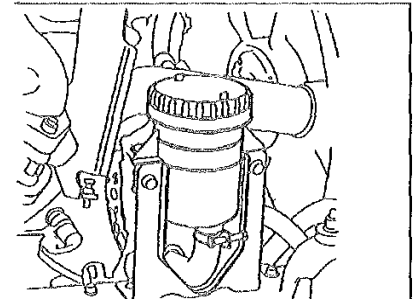
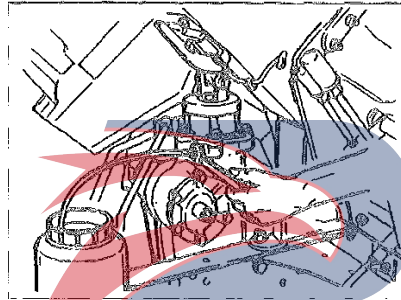
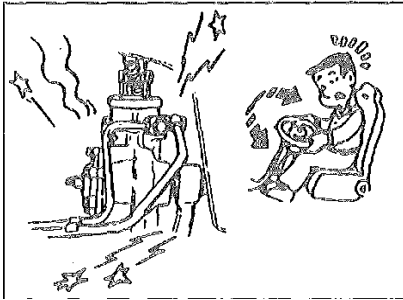

Deflation:

When turning the steering wheel, if abnormal noise is heard, it means that there is air in the hydraulic system. Therefore, the air should be exhausted as described below.

1. Jack the front wheel from the ground.
2. Remove the bleeder valve cover on the upper part of the steering device and bump the ethylene pipe into the bleeder valve.
Place the other end of the vinyl tube into a clean container.
3. Rotate the steering wheel to the locked position and loosen the vent screw to allow the loop to exhaust. Immediately after draining the oil and air bubbles, tighten the drain valve.
4. Turn the steering wheel to the locked position on the other side and repeat the above steps.
When the ventilation is performed, must check the fluid level and add it if necessary.

5. After the air is completely exhausted, must install the drain valve lid and check the liquid level. Then, with the front wheels on the ground, check the steering system to see if there was any oil leakage.
6. Carry out a test run to check whether the steering wheel is operated smoothly and whether there is any abnormal noise.

POWER STAR

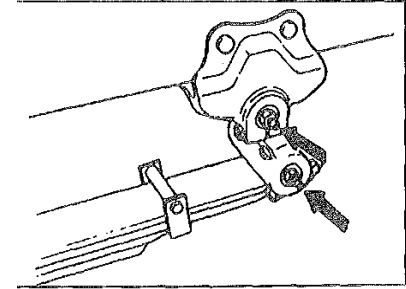
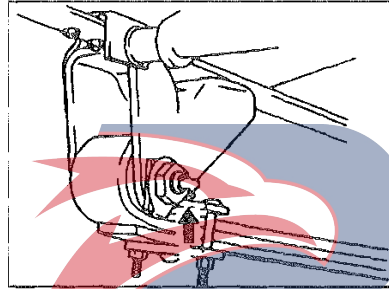
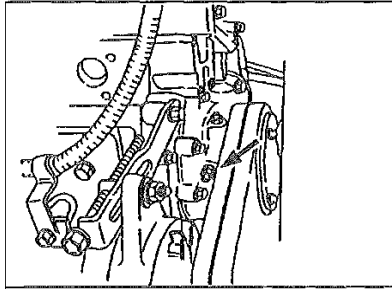

Parts for grease filling

Lubricate the following positions with chassis or multi-purpose grease. See the section “Recommended Use of Lubricant and Diesel Fuel” on page 127.

Engine water pump bearing (1 point)

Lubricant Type Multi-purpose Lubricant NLGI

No. 2

Front spring pin (2 points)

Front eye pin (4 points)

POWERSTAR

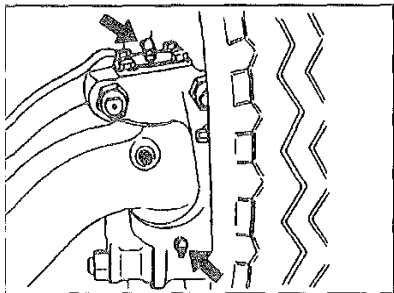

Kingpin hole of steering knuckle (4 points)

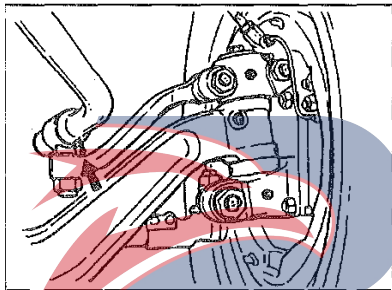

Steering drag rod (2 points)
(Except for maintenance-free type)

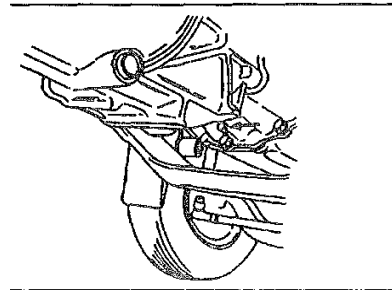

Steering clutch release bearing sleeve(1 points)
Lubricant Type Multi-purpose Lubricant NLGI
No. 2

POWERSTAR

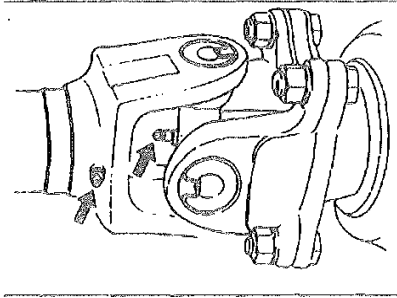

Drive shaft knuckle universal joints and sliding sleeve

Lubricant Type Multi-purpose Lubricant NLGI No. 2

Inject a sufficient volume of grease into the drive shaft knuckle until it overflows from the needle bearing seal (4 positions). After the grease has been filled, the spilled grease should be wiped clean.

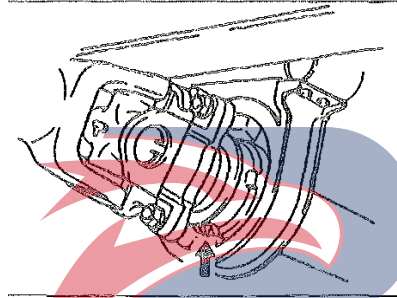

Central bearing of automobile transmission shaft (1 point)
Lubricant Type Multi-purpose Lubricant NLGI No. 2

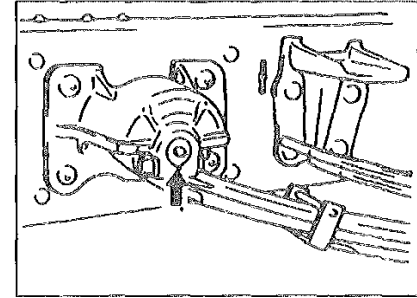

Rear spring pin (2 points)

POWERSTAR

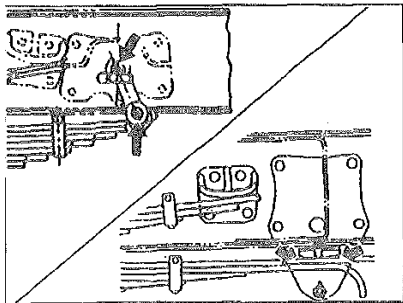

Rear eye pin (4 points)
Or the rear board (4 points)

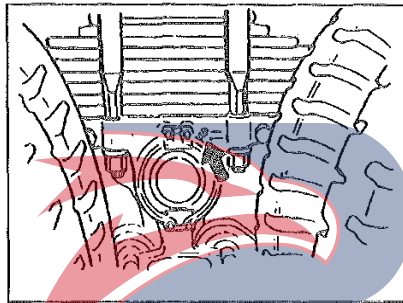

FVM Trunnion (2 points)
FVZ

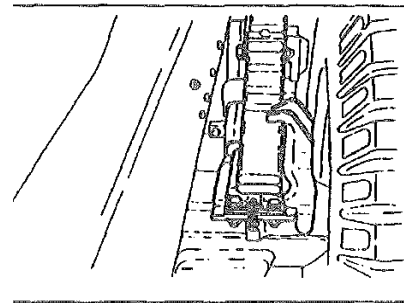

FVM Rear spring sliding pad (2 points)
FVZ

POWERSTAR

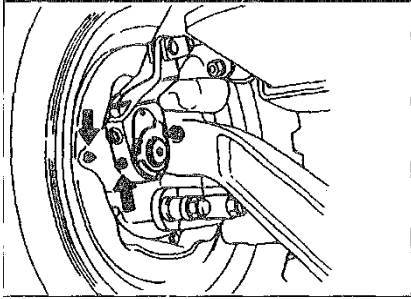

Front wheel brake camshaft and clearance adjustment mechanism (4 points)

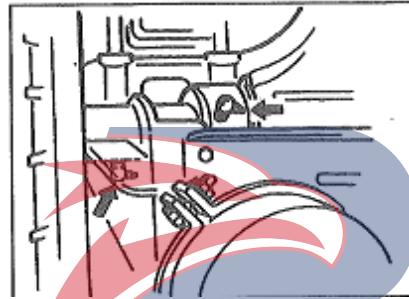

Rear wheel brake camshaft and clearance adjustment mechanism (4 points)

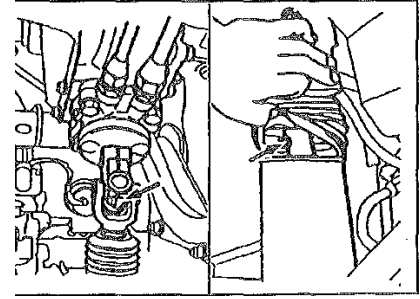

Universal disk universal point and sliding sleeve (3 points)

POWERSTAR



Use and maintenance of semi-trailer tractor (dedicated portion)

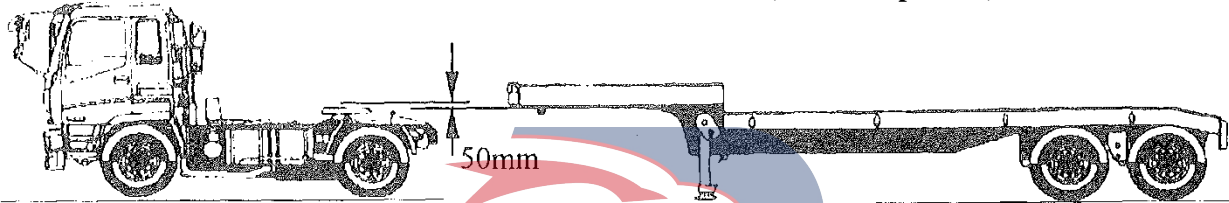

Operation Guide:

Before the towing vehicle is connecting or disconnecting with the semi-trailer, the entire train needs to stop on a flat surface with strong adhesion.

Connect the trailer:

1. Before the towing vehicle and trailer are coupled, confirm that the joint surfaces on the towing vehicle and the trailer are clean and well lubricated.
2. Check if the operating handle ⑦ of the traction seat is pulled out to the preset position (extending about 350mm). Otherwise, the following operations should be performed:
Lift the spring clip in front of the handle upwards, push the handle forward to the unlocked state, and pull the handle outward to the maximum position, and lock it on the traction seat panel by the clamping groove on the handle, at this time, the locking hook is in the open state.
3. Adjust the trailer supports so that the joint surface is about 50mm lower than the coupling surface of the traction seat of towing vehicle.
4. Align the center of the traction seat with the towing pin of the trailer, then, reverse the vehicle and the traction seat will lock automatically when it is in place.
5. Confirm that there is no gap between the traction seat and the trailer coupling surface.
6. Check whether the operation handle can automatically retract and whether the spring clip can be returned (indicating that the traction seat is automatically locked); otherwise, the above steps should be repeated.
7. Connect the seven-core cable connector at the rear of the cab of the towing vehicle and the fixed socket at the front of the trailer reliably, and check whether the lights and signals of the trailer are normal.
8. The red spiral tube at the rear of the cab of the tractor is the energy supply pipeline and the yellow spiral tube is the control pipeline. The palm-type connector at the end of the spiral tube of the towing vehicle is connected with the fixed connector corresponding to the color mark on the towing vehicle. Open the ball valve at the rear of the cab, and check the brake cylinder is sensitive and reliable or not.



Remove the trailer:

Adjust the height of the trailer supports so that the traction seat can be raised to the maximum height (the saddle is in the non-loaded state, but be careful not to allow the trailer to lift the saddle up).

1. Close the ball valve at the rear of the cab and remove the electrical and pneumatic connections between the towing vehicle and the trailer;
2. Lift up the spring clip in front of the handle and push the handle forward to the unlocked state. Pull out the operating handle quickly to the maximum position and move it forward, and automatically lock it by the clamping groove on the handle.
3. Driving the towing vehicle out and the mechanical device of the traction seat is in the stand-by state.

The traction seat is an important security component that connects the towing vehicle and the trailer! This traction seat is suitable for trailers with 50# traction pins.

Maintenance guide: (refer to the drawing of the traction seat for the part numbers mentioned in the following)

1. After using for more than 5000km, the trailer should be removed for every week for inspection. Clean the joint surface between the tractor and the trailer, and use pressure-resistant grease to lubricate the tractor's joint panel, lock mechanism, center "throat" of the tractor seat, and trailer tractor pins. The high-pressure grease containing MoS₂ or graphite additive is recommend, such as: BPL2M, BPHTEP1, BPLS2, Esso M-class, Shell, Retinax AM. Check whether the operation handle ⑦ and the connecting rod ⑥ are flexible, and clean and lubricate the shaft.
2. The rotating pin (17) of the traction seat is maintenance-free. According to the use condition, the wear condition should not be checked from 50,000 to 100,000 km without jacking up.
3. Routine inspection: Check daily for the deformation of the traction seat assembly, the corrugated board and the connecting plate, the traction pin and its connecting bolts, and whether the fastening bolts meet the tightening torque requirements.

Bolt tightening torque between the traction seat, corrugated plate, backing plate and frame: 240 ± 20 N.m (when the initial driving distance is 1000km, full inspection shall be carried out)

Note: 1. It is important to lubricate the above parts before the first use, which helps to increase the life of the parts and reduce the failure.

2. The mating surfaces of the lock hook ① and the wedge block ④ must not contain oil or grease.

POWERSTAR



Structure diagram of JOST saddle traction seat (JSK36DV only)

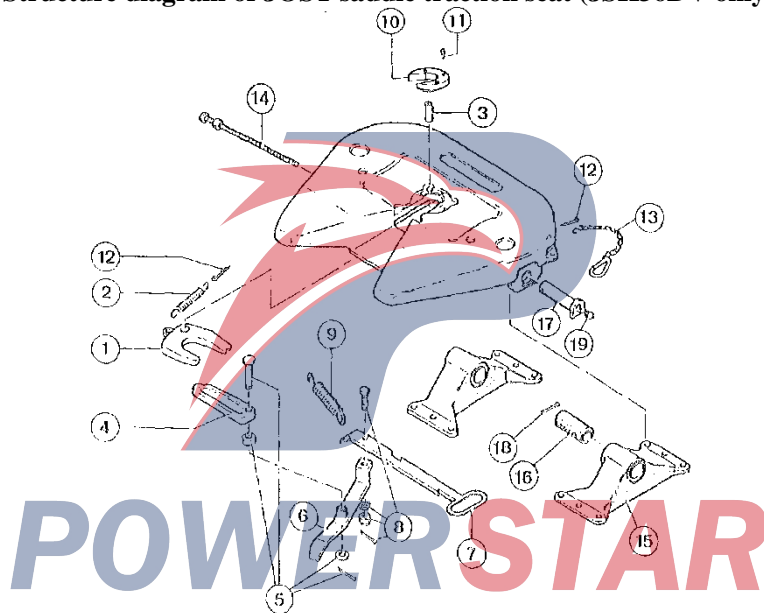

Special statement:

If the traction seat fails, please contact the traction seat manufacturer or the special repair station of QingLing Brake for repairs. Do not disassemble without authorization! Please use the genuine parts from the tractor manufacturer. The company will not be responsible for any quality accident caused by non-original parts.



Special equipment operation

Electronic Tuning AM Radio with Clock

- ① ON/OFF button switch
- ② Tone control knob
- ③ Reset button
- ④ station selection/tuning button (^ ∨)
- ⑤ Preselected station buttons
- ⑥ Display buttons
- ⑦ Electronic digital clock

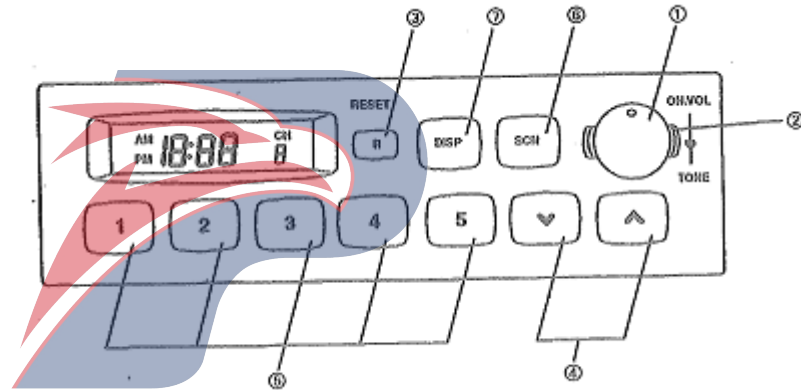

POWERSTAR

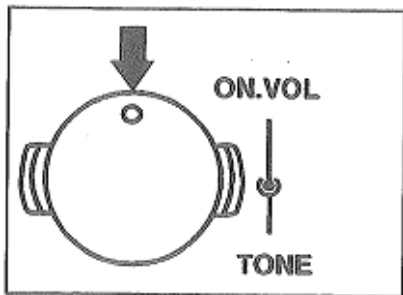

① ON/OFF button switch

Press this switch to turn on the radio.

Press it again to turn off the radio.

Volume control knob

Turn the knob clockwise to increase the volume, and counterclockwise to decrease the volume.

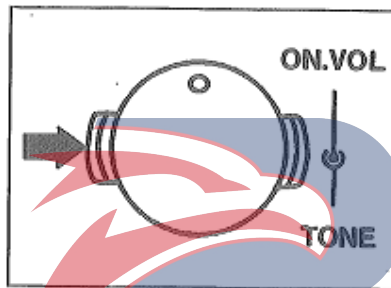

② Tone control knob

Turn the knob clockwise to increase the treble, and turn it counterclockwise to increase the bass.

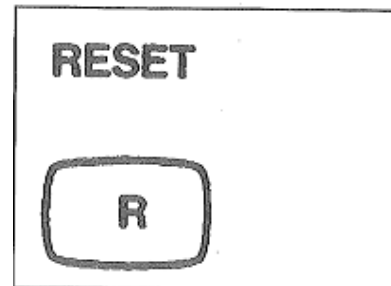

③ Reset button

Press this reset button to reset the displayed value of minutes (± 30 minutes). When the current displayed minute value is 30s or less, if pressing the button, the displayed minute value will be reset to "00", but the displayed hour value is not changed. If the current value of minutes is "31" or more, the value of minutes is reset to "00", and the value of hours increase by 1. The display value will be counted from 0s.

POWERSTAR

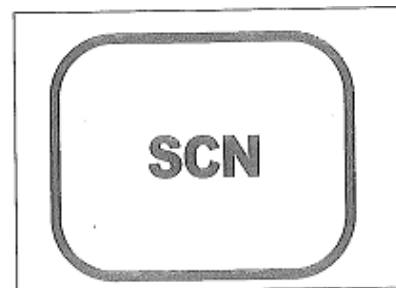
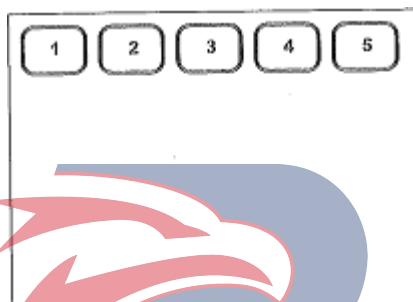
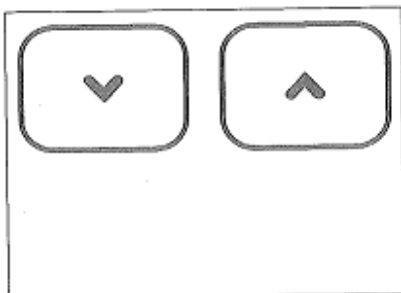

④ Selection station/harmonic button (∧∨)

To use these buttons, first press “DISP” button and select the frequency display mode on the display.

Press the “∧” button, and the frequency increases.

Press the “∨” button, and the frequency decreases.

Automatic tuning:

Press one of the buttons for more than 0.5 seconds to select the auto-tuning method. When the radio detects a valid frequency and its value is displayed on the screen, the frequency change will stop automatically.

Manual tuning:

If the radio is used in an area where it is not easy to receive broadcasts or is in a weaker radio (weak electric field) ambient, press the above button a very short time (within 0.5s) to enter the manual tuning mode. Each time the button is pressed, the frequency displayed increases or decreases by 1 kHz.

⑤ Preselected station buttons

The device is equipped with 5 preselected station buttons and each is used to preset one AM broadcast station.

Preset the frequency of each station:

Press and hold a preselected station button for more than 1.5s to record the broadcast station in memory.

Preselected station listening method:

Press the desired preselected station button for less than 1.5 seconds.

Scan button

When the “SCN” button is pressed, the sweep from the current frequency value to the higher frequency starts automatically.

When a broadcast station is received, the scanning will be paused and the station will be played for 5s. Then, return to the automatic scan mode again.

If the button is pressed again within 5s from the start of receiving a radio station, it will exit the automatic scanning mode and continue to receive the station.

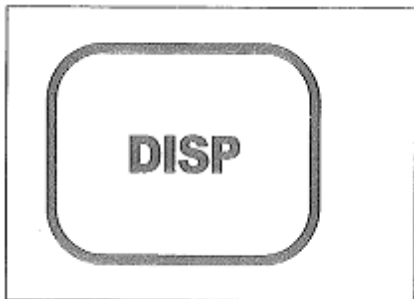

⑥ Display buttons

Each time the “DISP” (display) button is pressed, displaying clock is switched to the displaying frequency.

⑦ Electronic digital clock

If the clock needs to be adjusted, first press and hold the “DISP” button for more than 1.5 seconds. At the time, the time value will flash.

· Reset of hours

The display changes from 1 to 12 [AM (morning) or PM (afternoon)] every time the “∨” button is pressed (within 0.5 seconds). To increase quickly, press and hold this button without letting go. At this time, since the displayed value of hour is in a changing state, the displayed value of minute remains unchanged.

· Reset of minutes

Each time the “^” button is pressed, the display changes from 00 once through 59. Press and hold the button to quickly increase the displayed minute value. At this time, the displayed value does not change.

Pressing the “DISP” button again will return the current time mode.

POWER STAR



Cassette player with electronically tuned radio and clock (if equipped)

- ① ON/OFF button switch
- ② Left and right balance control
- ③ Audio control buttons
- ④ Preselected station buttons
- ⑤ Selection button of AM/FM band
- ⑥ Scanning button
- ⑦ Electronic digital clock
- ⑧ Alarm clock button
- ⑨ Fast forward/reverse button (FF/REW)
- ⑩ box out button

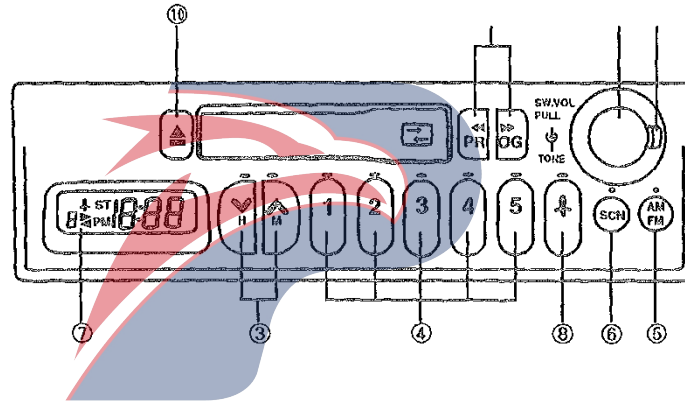

POWERSTAR

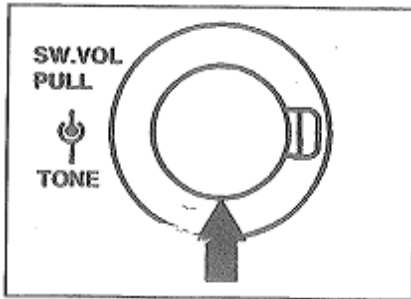

① ON/OFF button switch

Press this switch to turn on the radio.
Press it again to turn off the radio.

Volume control knob

Turn the knob clockwise to increase the volume, and
counterclockwise to decrease the volume.

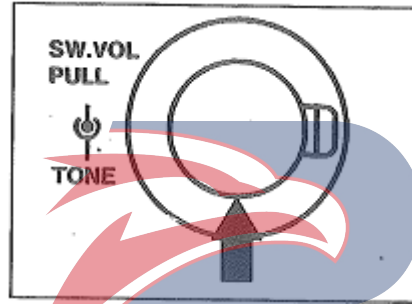

Left and right balance control

Pull out the left and right balance control knob and
turn it in any direction to set the optimal stereo outputs
of the left and right speakers.

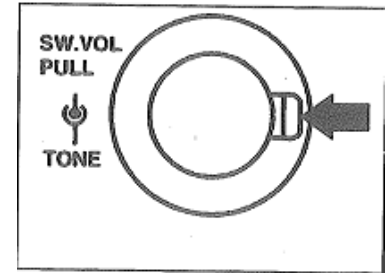

② Tone control knob

Turn the knob clockwise to increase the treble, and
turn it counterclockwise to increase the bass.

POWERSTAR

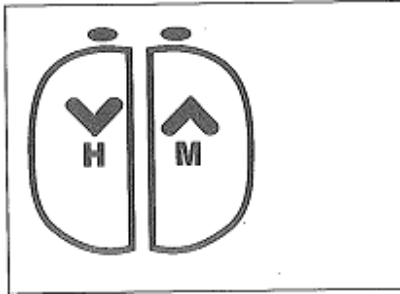

③ Station selection/tuning button (\wedge \vee)

Press the “ \wedge ” button, and the frequency increases.

Press the “ \vee ” button, and the frequency decreases.

Automatic tuning:

Press one of the buttons for more than 0.5 seconds to select the auto-tuning method. When the radio detects a valid frequency and its value is displayed on the screen, the frequency change will stop automatically.

Manual tuning:

If the radio is used in an area where it is not easy to receive broadcasts or is in a weaker radio (weak electric field) ambient, press the above button a very short time (within 0.5s) to enter the manual tuning mode. Each time the button is pressed, the frequency display increases or decreases by 1 kHz (amplitude modulation) or 0.1 MHz (frequency modulation).

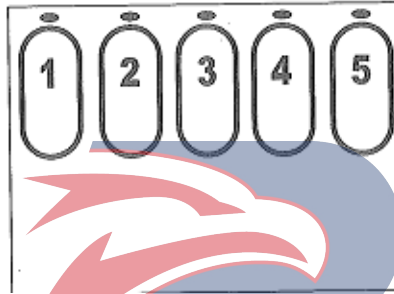

④ Preselected station buttons

The device is equipped with 5 preselected station buttons and each is used to preset one AM broadcast station.

Preset the frequency of each station:

Press and hold a preselected station button for more than 1.5 seconds. A “Beep” sound indicates that the radio station is recorded in the memory.

Preselected station listening method:

Press the desired preselected station button for less than 1.5 seconds.



⑤ Selection button of AM/FM band

Press the button to alternately select AM or FM band.

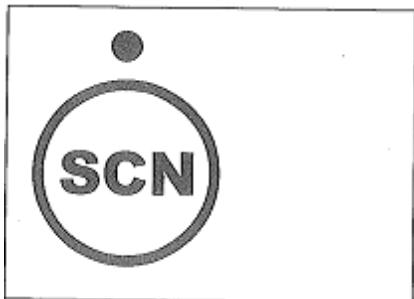

⑥ Scanning button

When the “SCN” button is pressed, the sweep from the current frequency value to the higher frequency starts automatically.

When a broadcast station is received, the scanning will be paused and the station will be played for 5s. Then, return to the automatic scan mode again.

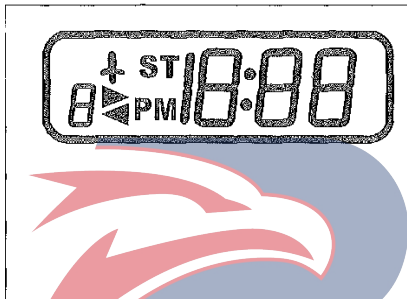

⑦ Electronic digital clock

·Reset of hours

Hold down the frequency modulation/amplitude modulation(AM/FM) button and press the “∨” button at the same time to increase the displayed value of hour.

·Reset of minutes

Hold down the frequency modulation/amplitude modulation (AM/FM) button and press the “∧” button at the same time to increase the value of minutes.

If the value of hours needs to be adjusted, you need to press the AM/FM button and the preselected station button (No. 3) at the same time.

When the preselected station button is pressed, if the current value of minutes is “30” or less, the value of minutes is reset to “00”. If the displayed minute value is “31” or above, the displayed hour value will be increased by 1h.

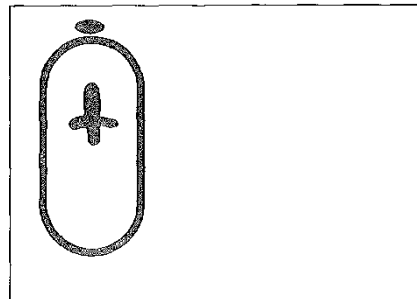

⑧ Alarm clock button

Press and hold the alarm button for more than 1.5 seconds to select the alarm mode. During the alarm mode setting, the display will always show the alarm tag.

The tuning button should be used when the alarm clock sounds. When the alarm time is reached, the alarm will sound. To stop the alarm, press this button. When the alarm sounds, if any button is not pressed, it will sound continuously for 3min.

To select the on or off state of alarm, press the alarm button. When the alarm is on, an alarm mark will appear on the display.

To confirm that the alarm sounds for a set time, hold the alarm button for more than 1.5 seconds. Press the alarm button again to return to the current time display.

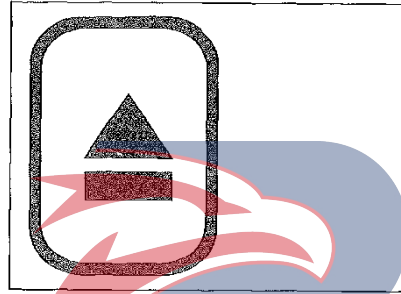
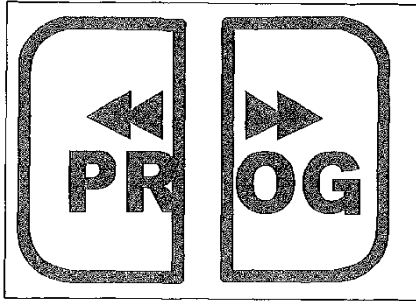

⑨ **Fast forward/reverse button (FF/REW)**

When the FF/REW button is pressed, the button is locked and the tape advances quickly or rewinds. More specifically, if you press the button on the same side of the tape drive direction displayed on the display screen, the fast forward will be performed. If pressing the button on the other side, the fast backward will be performed. To stop fast forwarding or fast rewinding, press the other side button opposite to the tape drive direction lightly. When a song is played, it automatically plays the next song. If pressing the (FF/REW) button, the tape playback order will be always changed.

⑩ **box out button**

When the take-out button is pressed, the cassette is ejected.

POWERSTAR

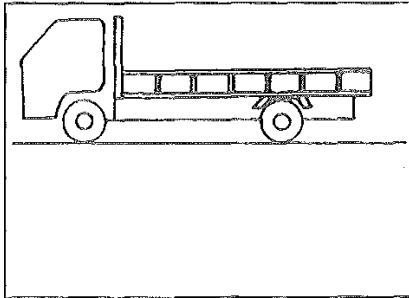

Cargo loading method

1. QingLing trucks classified by usage

① General truck

(Applicable to general groceries, foods, etc. that are transported in boxes.)

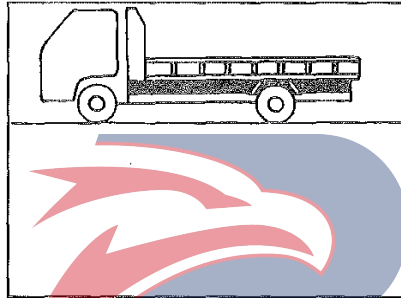

② Heavy truck

(Applicable to transportation of bulk materials such as steel and cereals.)

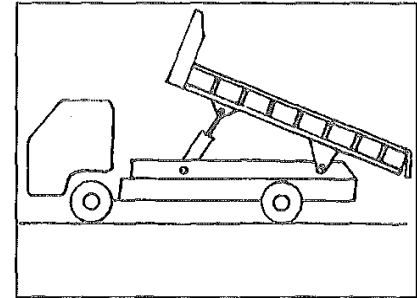

③ Dump trucks

(Applicable to transport soil, sand, etc.)

POWERSTAR

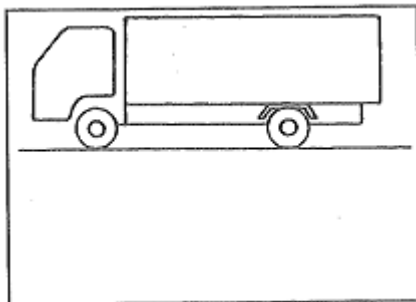

④ Box truck

(Applicable to transport sensitive materials such as rain, dust, etc.)

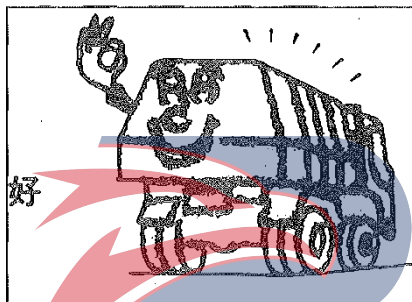

2. Loading limit

① The cargo width should not exceed the outside of the compartment

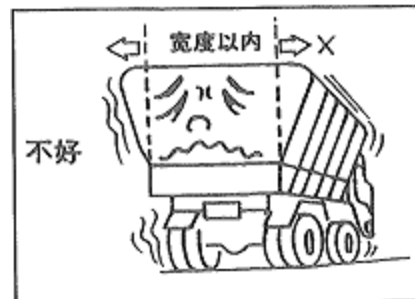

POWERSTAR

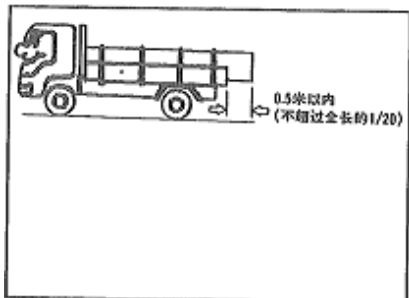

② Do not let the goods stick out of the truck bed as much as possible.

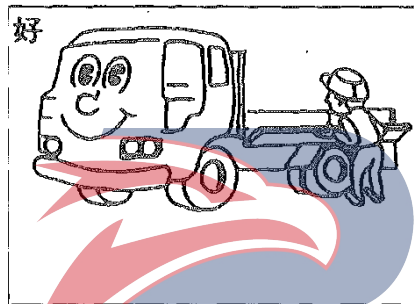

3. Loading instance

① Gently open and close the car.

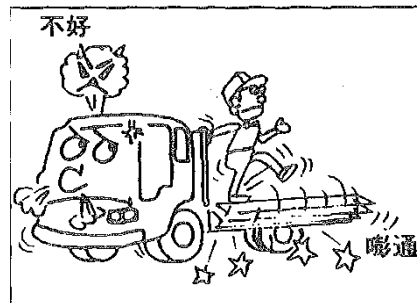

Rough operation will shorten the life of the carriage

POWERSTAR

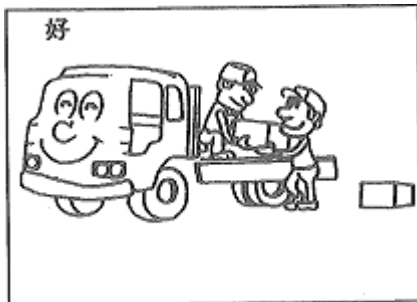

② Carefully loading and unloading

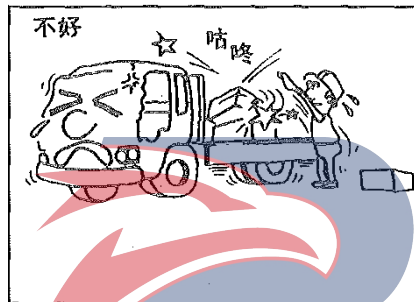

Throwing cargo will hurt the cargo and the carriage.

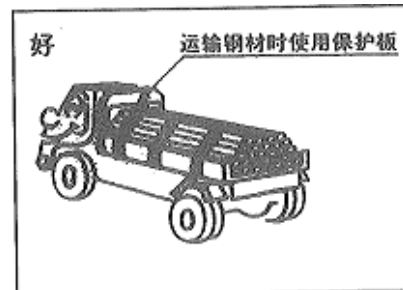

③ The cargo should be tied tight with ropes

POWERSTAR

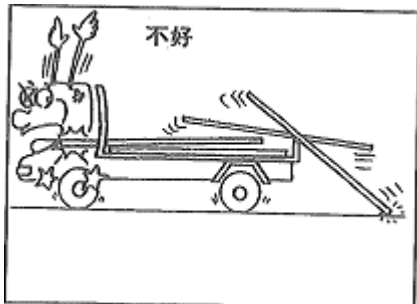

If it is not fixed, the materials will be scattered during the journey

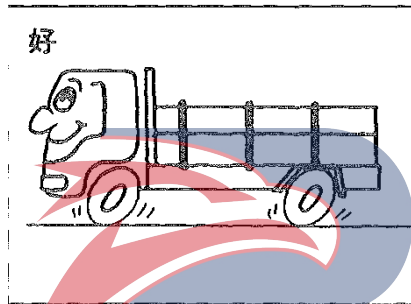

④ The cargo should be loaded low and evenly

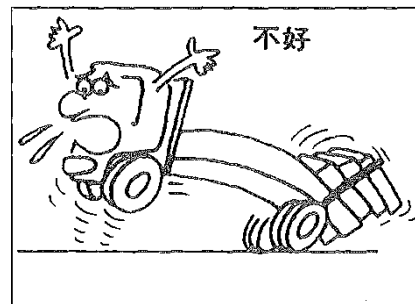

Unbalanced loading can not only make driving unstable, but also damage the cargo and the vehicle.

POWERSTAR

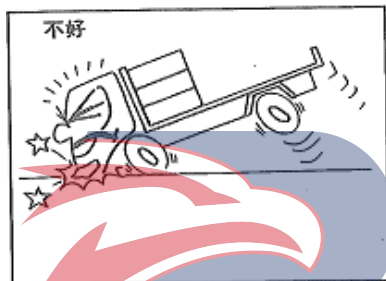
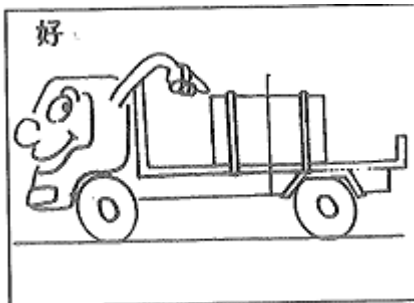

The relatively tall cargo should be fixed in the center of the compartment.

POWERSTAR

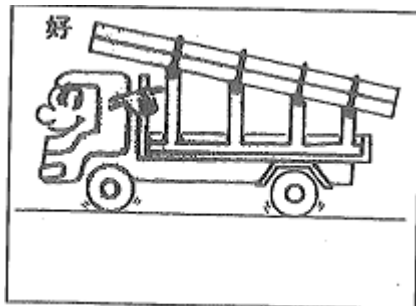

⑤ Long goods should be placed on a shelf

Caution:

- Vehicle limits should give priority to regulatory restrictions.
- Since this kind of loading method may cause the center of gravity of the vehicle to increase, the vehicle may turn over. Therefore, be sure to pay attention to driving operations such as high-speed driving, sudden braking, and sudden steering when driving.

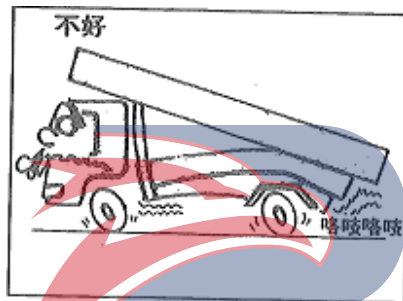

Only the front frame and the rear door are used to support the trunk.

※ The rack should be counted as part of the goods.

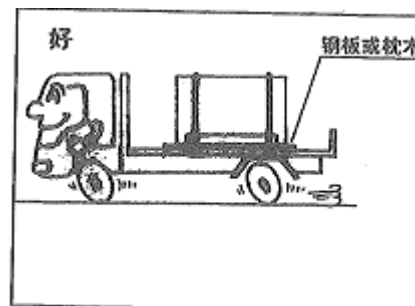

⑥ The concentrated weight should be distributed with weight distribution measures

POWERSTAR



The first time	During a crash
The second time	After 1 month
The third time	After 6 months
After the fourth time	Every 6 months



For safety and automotive life

POWERSTAR



Type of Truck	Loading method	Method for protecting box
Timbers, telephone poles, iron pipes, and other long objects		Protection material (wood or iron) for front sideboard pad, with pillars, or sleepers

Transmission gear ratio and oil capacity

Transmission ratio (ratio 1)		1st gear	2nd gear	3rd gear	4th gear	5th gear	6th gear	Reverse gear
ISUZU	MLD6A	8.761	5.533	3.569	2.389	1.533	1	8.896
	MLD6Q	6.720	4.244	2.580	1.540	1	0.763	6.823
	MRB6P	7.027	4.277	2.493	1.500	1	0.780	7.038
Lubricant capacity L		MLD6 gear type: 6.5 including power-retrieving device: +0.7 MRB6P gear type:7.8						

The values in the table are estimates and are for reference only.

The oil level must be measured with a dipstick or a suitable oil level gauge

POWERSTAR



Cargo loading method

Type of Truck	Loading method	Method for protecting box
Debris, sand, gravel, bulk cargo		When loading sand, gravel, brick and other goods, use side fence protection materials and hang ropes.
Goods that are piled high such as groceries.		Hang a rope on the rope hook.
<p>The machinery and equipment components and other large cargo.</p> <p><Note> The cargo deck center refers to the intersection of cargo compartment floor diagonals, and the center line of the cargo deck refers to the line that passes through the intersection point and is vertical to the floor.</p>		The iron floor, plywood, or longitudinal pad sleepers are placed on the floor of the container.



Model		FVR33P	FVR34P	FVM34Q	FVZ34Q	CXA34T
Gross vehicle mass	kg	15000±100	15000±100	20000±100	21500±100	24500±100
Loading mass	kg	8000	8000	11500	12000	15000
Kurb mass	kg	7000±100	7000±100	8500±100	9500±100	9500±100
Number of passengers allowed in the cab	Person	3	3	3	3	3
Engine Model		6HH1	6HK1	6HK1-TC		6HK1-TC
		4-stroke, water-cooled SOHC, 4-valve diesel, naturally aspirated	4-stroke single, water-cooled SOHC, 4-valve diesel, supercharged, intercooled	4-stroke, water-cooled SOHC, 4-valve diesel, supercharged, intercooled		4-stroke single, water-cooled SOHC, 4-valve diesel, supercharged, intercooled
Number of cylinders		6	6	6		6
Compression ratio		18.5:1	17.5:1	16.9:1		16.9:1
Inner diameter × stroke		115x132	115x125	115x125		115x125
Displacement	L	8.226	7.79	7.79		7.79
Maximum power	kw/rpm	136/2850	169/27:30	191/2500		191/2500
Maximum torque	N. m/rpm	490/1700	666/1700	745/1500		745/1500
Fuel type		No. 0 is used in the south; in winter in the north, suitable fuel is selected according to the ambient temperature				
Fuel tank capacity	L	200				

POWERSTAR



Main data and specifications

Model		FVR33P	FVR34P	FVM34Q	FVZ34Q	CXA34T
General dimensions						
Outline dimensions	Full length	9650±50	9650±50	9535±50	9535±50	10300±50
	Full width	2465±30	2465±30	2465±30	2465±30	2465±30
	Full height	2810±30	2810±30	2810±30	2810±30	2810±30
Wheelbase		5550±50	5550±50	5950±50	5950±50	6400±50
Wheel base	Front wheel	1960±30	1960±30	1960±30	1960±30	1960±30
	Rear wheel	1855±30	1855±30	1855±30	1355±30	1855±30
Dimension inside the vehicle (reference)						
	Full length	7250±50	7250±50	7100±50	7100±50	7950±50
	Full width	2330±50	2330±50	2330±50	2330±50	2340±50
	Full height	450±50	450±50	450±50	450±50	448±50
Minimum ground clearance	mm	255	255	255	255	255
Minimum turning radius	m		9,4±1			10,9
Drive type		4×2	4×2	6×2	6×4	6×4
Number of axes		2	2	3	3	3
Weight						

POWERSTAR



Model		FVR33P	FVR34P	FVM34Q	FVZ34Q	CXA34T
Transmission		MLD-6A	MLD-6Q		MRB-6P	MRB-6P
Model						
Clutch						
Type			One-piece, dry type, with buffer spring			
Diameter		350		380		380
Pedal free play	mm			45-65		
Rear axle						
Type			Integral axle housing, full floating drive axle			
Gear ratio		5.571	6.142	6.142	6.429	6.429
Lubricant capacity	L	14	14	14	Front and rear axles: 18 Rear axles: 12	Middle axle: 18 Rear axles: 12
Front axle						
Type			Punch - end type, I-shaped cross section			
Steering mechanism						
Type			Overall power recirculating-ball type			
Steering wheel free play	mm			10-60		
Power steering oil capacity	L			3.4		

POWERSTAR



Model	FVR33P	FVR34P	FVM34Q	FVZ34Q	CXA34T
Front wheel positioning angle					
Toe-in	mm	-1-1			0±1
Camber	°	0°30'±30'			0°30'±10'
Caster	°	2°±50'			2°±50'
King pin angle	°	7°30'±1°			7°30'±1°
Service brake Type		All pneumatic, dual circuit			
Pedal free play		9-14			
Parking brake Type	mm	Spring brake mounted on rear wheel			
Suspension Type	Front	Semi-ellipse alloy leaf spring with hydraulic bidirectional drum shock absorber			
	Rear	Semi-ellipse alloy leaf spring	suspension	Semi-ellipse alloy leaf spring with cross	
Wheel					
Tire size	Front	10.00-20-16PR (Optional: 10.00-20-16PR)			11.00R20-16PR (Optional: 11.00-20-18PR)
	Rear	10.00-20-16PR (Optional: 10.00-20-16PR)			11.00R20-16PR (Optional: 11.00-20-18PR)

POWERSTAR



Model	FVR33P	FVR34P	FVM34Q	FVZ34Q	CXA34T
Electrical device	24V system with negative grounding				
Type	12V-115A, h (2)				
Battery	V/Ah	24/4.5			
Starter	V/kw	24/40			
Generator	V/A				

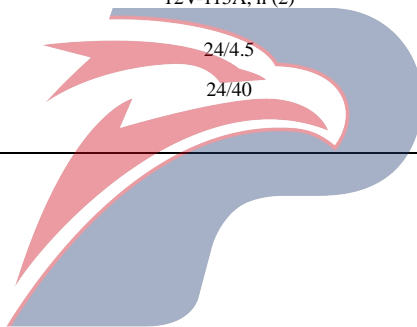

POWERSTAR



Model		FVR33PX	FVR34PX	FVR34SX	FVM34QX	FVZ34QX	FVZ34VX
General dimensions							
Outline dimensions	Full length	9600±50	9600±50	11120±50	9600±50	9600±50	11685±50
	Full width	2485±30	2485±30	2495±30	2485±30	2485±30	2495±30
	Full height	3670±30	3670±30	3970±30	3670±30	3670±30	3950±30
Wheelbase		5550±50	5550±50	6300±50	5950±50	5950±50	7000±50
Wheel base	Front wheel	1960±30	1960±30	1960±30	1960±30	1960±30	1960±30
	Rear wheel	1855±30	1855±30	1855±30	1855±30	1855±30	1855±30
Dimension inside the vehicle (reference)							
	Full length	7120±100	7120±100	8600±50	7120±100	7120±100	9350±50
	Full width	2385±100	2385±100	2400±50	2385±100	2385±100	2400±50
	Full height	1995±100	1995±100	2550±50	1995±100	1995±100	2550±50
Minimum ground clearance	mm	255	255	255	255	255	255
Minimum turning radius	m	9.4±1	9.4±1	10.9	9.4±1	9.4±1	10.9
Drive type		4×2	4×2	4×2	6×2	6×4	6×4
Number of axes		2	2	2	3	3	3
Weight							

POWERSTAR



Model	FVR33PX	FVR34PX	FVR34SX	FVM34QX	FVZ34QX	FVZ34VX	
Gross vehicle mass	kg	15000±100	15000±100	15500±100	20000±100	21500±100	21580±100
Loading mass	kg	7300	7300	7270	11000	12000	11200
Kurb mass	kg	7700:1:100	7700±100	8230±100	9000±100	9500±100	10380±100
Number of passengers allowed in the cab	Person	3	3	3	3	3	3
Engine Model		6HHI 4-stroke, water-cooled SOHC, 4-valve diesel, naturally aspirated	6HK1 4-stroke single, water-cooled SOHC, 4-valve diesel, supercharged, intercooled	6HK1 4-stroke single, water-cooled SOHC, 4-valve diesel, supercharged, intercooled	6HKI-TC 4-stroke, water-cooled SOHC, 4-valve diesel, supercharged, intercooled	6HKI-TC 4-stroke single, water-cooled SOHC, 4-valve diesel, supercharged, intercooled	
Number of cylinders		6	6	6	6	6	
Compression ratio		18.5:1	17.5:1	17.5:1	16.9:1	16.9:1	
Inner diameter × stroke		115x132	115x125	115x125	115x125	115x125	
Displacement	L	8.226	7.79	7.79	7.79	7.79	
Maximum power	kw/rpm	136/2850	169/2700	169/2700	191/2500	191/2500	
Maximum torque	Nm/rpm	490/1700	666/1700	666/1700	745/1500	745/1500	
Fuel type		No. 0 is used in the south; in winter in the north, suitable fuel is selected according to the ambient temperature					
Fuel tank capacity	L	200					



Model	FVR33PX	FVR34PX	FVR34SX	FVM34QX	FVZ34QX	FVZ34VX
Transmission						
Model	MLD-6A	MLD-6Q	MLD-6Q		MRB-6P	MRB-6P
Clutch						
Type	One-piece, dry type, with buffer spring					
Diameter		350		380		
Pedal free play	mm		45-65			
Rear axle						
Type	Integral axle housing, full floating drive axle					
Gear ratio	5.17	6.142	6.142	6.142	6.249	6.249
Lubricant capacity	L	14	14	14	14	14
Front axle						
Type	Punch - end type, T-shaped cross section		Punch - end type, I-shaped cross section		Punch - end type, T-shaped cross section	Punch - end type, I-shaped cross section
Steering mechanism						
Type	Overall power recirculating-ball type					
Steering wheel free play	L			10-60		
Power steering oil capacity				3.4		

POWERSTAR



Model		FVR33PX	FVR34PX	FVR34SX	FVM34QX	FVZ34QX	FVZ34VX
Front wheel positioning angle							
Toe-in	mm	-1-1		0±1		-1-1	0±1
Camber	°	0°30'±30'		0°30'±10'		0°30'±30'	0°30'±10'
Caster	°			2°±50'			
King pin angle	°			7°30'±1°			
Service brake		All pneumatic, dual circuit					
Type		9-14					
Pedal free play		Spring brake mounted on rear wheel					
Parking brake	mm						
Type		Semi-ellipse alloy leaf spring with hydraulic bidirectional drum shock absorber					
Suspension		Semi-ellipse alloy leaf spring Semi-ellipse alloy leaf spring with cross suspension					
Type	Front						
	Rear						
Wheel							
Tire size	Front	10.00-20-16PR (Optional: 10.00-20-16PR)					
	Rear	10.00-20-16PR (Optional: 10.00-20-16PR)					
Electrical device							

POWERSTAR



Model	FVR33PX	FVR34PX	FVR34SX	FVM34QX	FVZ34QX	FVZ34VX
Type	24V system with negative grounding					
Battery	V/A.h 12V-115A, h (2)					
Starter	V/kw 24/4.5					
Generator	V/A 24/40					



POWERSTAR



Main data and specifications

Model		FVR33G Type II chassis	FVR34J	FRVR34S	FVZ34K Type II chassis	FVZ34N	FVZ34V	GVR34F	GVR34F1
General dimensions									
Outline dimensions									
	Full length	6535 ± 50	7770 ± 50	10785 ± 50	7085 ± 50	8585 ± 50	11685 ± 50	5990 ± 50	5990 ± 50
	Full width	2385 ± 30	2465 ± 30	2465 ± 30	2385 ± 30	2465 ± 30	2465 ± 30	2465 ± 30	2465 ± 30
	Full height	2810 ± 30	2810 ± 30	2810 ± 30	2810 ± 30	2810 ± 30	2810 ± 30	2810 ± 30	2810 ± 30
Wheelbase									
	Front wheel	3900 ± 50	4500 ± 50	6300 ± 50	4700 ± 50	5300 ± 50	7000 ± 50	3750 ± 50	3750 ± 50
Wheel base									
	Rear wheel	1960 ± 30	1960 ± 30	1960 ± 30	1960 ± 30	1960 ± 30	1960 ± 30	1960 ± 30	1960 ± 30
Dimension inside the vehicle (reference)									
	Full length	1855 ± 30	1855 ± 30	1855 ± 30	1855 ± 30	1855 ± 30	1855 ± 30	1855 ± 30	1855 ± 30
Minimum ground clearance									
	Full width		5335 ± 50	8400 ± 50		6150 ± 50	9300 ± 50	牵引座接合面高度	
	Full height		2340 ± 50	2330 ± 50		2340 ± 50	2330 ± 50	空载: 1300 空载: 1300	
	mm		480 ± 50	450 ± 50		480 ± 50	450 ± 50	满载: 1250 满载: 1250	
Minimum turning radius									
	m	2.55	2.55	2.55	2.55	2.55	2.55	2.55	2.55
Drive type									
	Number of axes	7. 8	7. 5	10. 9	8. 4	8. 5	10. 9	6. 5	
Weight									
	kg	4 × 2	4 × 2	4 × 2	6 × 4	6 × 4	6 × 4	4 × 2	4 × 2
Gross vehicle mass									
	kg	2	2	2	3	3	3	2	2
Loading weight									
	kg	15000 ± 100	15000 ± 100	15500 ± 100	21500 ± 100	21500 ± 100	21595 ± 100	30000 ± 100	30000 ± 100
Equipment mass									
	kg	5000 ± 100	8200	8000	6700 ± 100	12600	12000	鞍载: 9000	
	kg	5000 ± 100	6800 ± 100	7500 ± 100	6700 ± 100	8900 ± 100	9595 ± 100	5500 ± 100	



Main data and specifications

Model		FVR33G Type II chassis	FVR34J	FRVR34S	FVZ34K Type II chassis	FVZ34N	FVZ34V	GVR34F	GVR34F1
Number of passengers in cab	Person	3	3	3	3	3	3	3	3
Engine									
Model		6HK1 4-stroke, water-cooled SOHC, 4-valve diesel, supercharged, intercooled			6HK1-TC 4-stroke, water-cooled SOHC, 4-valve diesel, supercharged, intercooled			6HK1-TC 4-stroke, water-cooled SOHC, 4-valve diesel, supercharged, intercooled	
Number of cylinders		6			6			6	
Compression ratio		17.5:1			16.9:1			16.9:1	
Inner diameter × stroke		115 × 125			115 × 125			115 × 125	
Displacement	L	7.79			7.79			7.79	
Maximum power	kw/rpm	169/2700			191/2500			191/2500	
Maximum torque	N.m/rpm	666/1700			745/1500			745/1500	
Fuel type		No. 0 is used in the south; in winter in the north, suitable fuel is selected according to the ambient temperature							
Fuel tank capacity	L	200							
Transmission		POWER STAR							
Model		MLD-6Q			MRB-6P			MRB-6P	
Clutch									
Type		One-piece, dry type, with buffer spring			One-piece, dry type, with buffer spring			One-piece, dry type, with buffer spring	
Diameter		380			380			380	
Pedal free play	mm	45-65			45-65			45-65	



Main data and specifications

Model	FVR33G Type II chassis	FVR34J	FRVR34S	FVZ34K Type II chassis	FVZ34N	FVZ34V	GVR34F	GVR34F1
Rear axle Type			Integral axle housing, full floating drive axle					
Gear ratio		6.142			6.249		6.667	6.142
Lubricant capacity	L	14			Middle axle: 18 Rear axles: 12		14	
Front axle Type		Punch - end type, I-shaped cross section		Punch - end type, I-shaped cross section			Punch - end type, I-shaped cross section	
Steering mechanism								
Type	mm	Overall power recirculating-ball type 10-65		Overall power recirculating-ball type 10-65			Overall power recirculating-ball type 10-65	
Steering wheel free play	L	3.4			3.4		3.4	
Power steering oil capacity								
Front wheel positioning angle								
Toe-in	mm	0 ± 1		0 ± 1			0 ± 1	
Camber	°	0°30' ± 10'		0°30' ± 10'			0°30' ± 10'	
Caster	°	2° ± 50'		2° ± 50'			2° ± 50'	
King pin angle	°	7°30' ± 1°		7°30' ± 1°			7°30' ± 1°	
Service brake Type		All pneumatic, dual circuit		All pneumatic, dual circuit			All pneumatic, dual circuit	
Pedal free play		9-14		9-14			9-14	
Parking brake	mm							

POWERSTAR



Main data and specifications

Model		FVR33G Type II chassis	FVR34J	FRVR34S	FVZ34K Type II chassis	FVZ34N	FVZ34V	GVR34F	GVR34F1
Type		Spring brake mounted on rear wheel			Spring brake mounted on rear wheel			Spring brake mounted on rear wheel	
Suspension		Ellipse rear alloy leaf spring with hydraulic bidirectional drum shock absorber							
Type	Front								
	Rear	Semi-ellipse alloy leaf spring			Semi-ellipse alloy leaf spring with cross suspension			Semi-ellipse alloy leaf spring	
Wheel		10.00-20-16PR			10.00-20-16PR			10.00-20-16PR	
Tire size	Front	(Optional 10.00-20-16PR)			(Optional 10.00-20-16PR)			(Optional 10.00-20-16PR)	
	Rear	10.00-20-16PR (Optional 10.00-20-16PR)			10.00-20-16PR (Optional 10.00-20-16PR)			10.00-20-16PR (Optional 10.00-20-16PR)	
Electrical device		24V system with negative grounding			24V system with negative grounding			24V system with negative grounding	
Type									
Battery	V/Ah	12-115A.h (2 个)			12-115A.h (2 个)			12-115A.h (2 个)	
Starter	V/kw	24/4.5			24/4.5			24/4.5	
Generator	V/A	24/40			24/40			24/40	
Towing connecting device									
Traction seat type									Saddle-type traction seat
Traction pin number									Number 50
Air tube specifications									Spiral pipe with a diameter of $\Phi 12 \times 1.5$ and a length of 4m (with palm connector)
Cable specification									Standard seven-core cable (with 24N electrical connector)

POWERSTAR



Tools with vehicle

SN	Name	Specifications	Quantity
1	Tool bag		1
2	Spanner		1
3	Extension bar - Wheel Wrench		1
4	Grease gun		1
5	Hydraulic jack assembly	QYH10D	1
6	Jaws 150	150	1
7	Monkey wrench 250	250	1
8	Wrench kit	10×12	1
9	Wrench kit	14×17	1
10	Wrench kit	19×22	1
11	Wrench kit	24×27	1
12	"-" Combination screwdriver		1
13	"+" Combination screwdriver		1
14	"+" Combination screwdriver		1
15	Hammer		1
16	Jack rocker		1
17	Wheel wrench - spare wheel		1

POWERSTAR



Additional descriptions

Use and maintenance of dual fuel tanks:

The vehicle is equipped with the dual fuel tanks to ensure its proper and safe use and maintenance.

Caution:

1. Before daily operation, check to make sure that the surface of the connecting pipe between the two fuel tanks is not damaged or leaking. If any, please purchase the genuine fuel hose parts with the same specifications for replacement.
2. When driving, please choose a good road as far as possible. Avoid breakage and loss of the connection pipe to the fuel tank caused by obstacles below vehicle.
3. According to the quality of the used oil product and the environment of the vehicle, after the vehicle is running for a period of time, please clean the two fuel tanks and the connection between them to ensure the normal connection of the two fuel tanks and prevent clogging.
4. When there is obvious deviation in the liquid level height of the two fuel tanks, please check and clean the oil outlet pipe joint at the bottom of the two fuel tanks and the connecting pipe between them.

POWERSTAR